

---

# User's Guide

---

## HP 8504B Precision Reflectometer

HP part number: 08504-90046  
Printed in USA March 1995

1400 Fountaingrove Parkway,  
Santa Rosa, CA  
95403-1799, USA

**Notice.** The information contained in this document is subject to change without notice. Hewlett-Packard makes no warranty of any kind with regard to this material, including but not limited to, the implied warranties of merchantability and fitness for a particular purpose. Hewlett-Packard shall not be liable for errors contained herein or for incidental or consequential damages in connection with the furnishing, performance, or use of this material.

**Restricted Rights Legend.** Use, duplication, or disclosure by the U.S. Government is subject to restrictions as set forth in subparagraph (c) (1) (ii) of the Rights in Technical Data and Computer Software clause at DFARS 252.227-7013 for DOD agencies, and subparagraphs (c) (1) and (c) (2) of the Commercial Computer Software Restricted Rights clause at FAR 52.227-19 for other agencies.

©Copyright Hewlett-Packard Company 1992, 1993, 1994, 1995  
All Rights Reserved. Reproduction, adaptation, or translation without prior written permission is prohibited, except as allowed under the copyright laws.

---

**WARNING**

This is a IEC Class 1 LED product. Do not stare into beam or view directly with optical instruments. LED radiation is emitted from the front-panel TEST PORT and REFERENCE EXTENSION A connectors.

---

**WARNING**

If this instrument is not used as specified, the protection provided by the equipment could be impaired. This instrument must be used in a normal condition (in which all means for protection are intact) only.

---

**WARNING**

No operator serviceable parts inside. Refer servicing to qualified personnel. To prevent electrical shock and LED radiation, do not remove covers.

---

**CAUTION**

Before switching on this product, make sure that the line-voltage selector switch is set to the voltage of the power supply and the correct fuse is installed. Assure the supply voltage is in the specified range.

---

**CAUTION**

Electrostatic discharge (ESD) can damage circuits associated with rear-panel connectors. Therefore, before connecting any cable to a rear-panel connector, momentarily short the center and outer conductors of the cable together. Avoid touching the rear-panel connectors without first touching the frame of the instrument. Be sure that the instrument is properly earth-grounded to prevent buildup of static charge.

---

This instrument has been designed and tested in accordance with IEC Publication 348, *Safety Requirements for Electronic Measuring Apparatus*, and has been supplied in a safe condition. The instruction documentation contains information and warnings which must be followed by the user to ensure safe operation and to maintain the instrument in a safe condition.

---

# The HP 8504B at a glance

The HP 8504B precision reflectometer is a high-resolution interferometer that measures return loss. It is optimized for single-mode fiber, but useful measurements can also be made in multi-mode fiber. The precision reflectometer performs measurements at 1300 nm and 1550 nm wavelengths.

Typical applications include:

- Measurements of launch optics for lasers and opto-electronic integrated circuits.
- Measurements of passive fiber-optic devices such as couplers, attenuators, connectors, and isolators.
- High-resolution measurements of lightwave path discontinuities based on a known refractive index.
- Measurement of refractive index of material based on a known distance between two discontinuities.
- High-resolution measurement of path length, expressed as transit time.
- Measurements of bulk optic devices such as lenses, AR coatings, and crystals.

Using the precision reflectometer, you can display multiple reflections from the device that you are testing. For example, the following figure shows an LED device with five reflective surfaces. For each surface, the figure shows the corresponding response on the precision reflectometer's display.

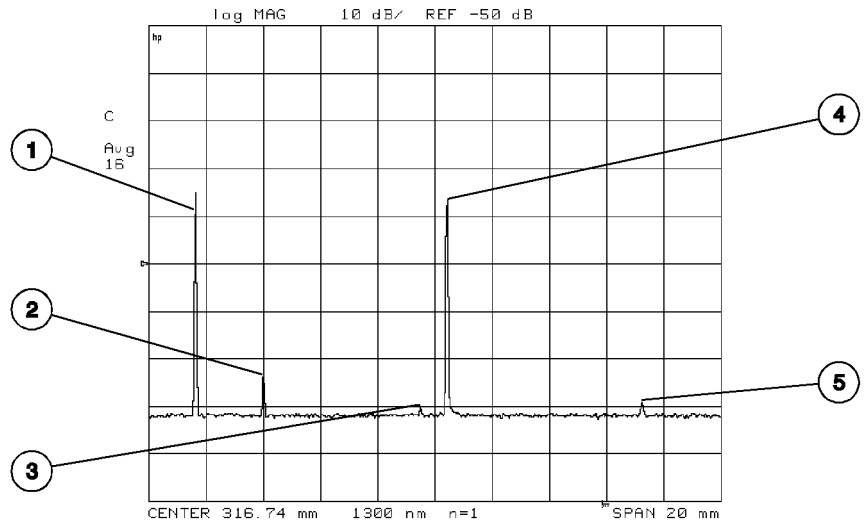
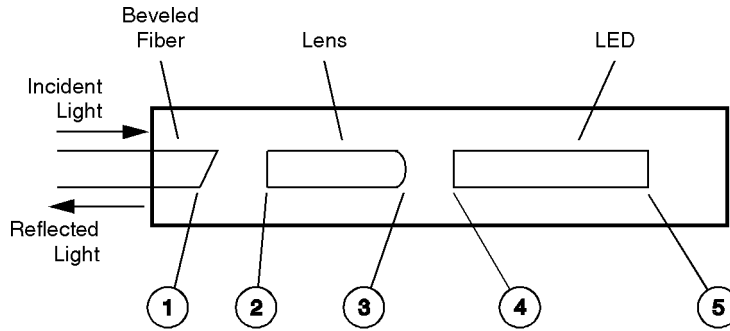

1meas

**Guided procedures  
reduce measurement  
time**

The precision reflectometer provides *guided setup* and *guided calibration* procedures that help you prepare the instrument for measurements. These procedures consist of a series of screens that present step-by-step instructions.

Procedure	Task
<i>guided setup</i>	Selects light source and calibrates the instrument for pigtailed or non-pigtailed devices.
<i>guided calibration</i>	Calibrates the instrument.

You can also manually calibrate the instrument for maximum flexibility. Refer to Chapter 2 for a complete explanation of *guided setups* and *guided calibrations*.

You should calibrate the instrument:

- After the instrument has warmed up for 1 hour.
- Before making any measurements.

**Front-panel adapters  
can be changed**

The precision reflectometer's three front-panel connectors are compatible with 9/125  $\mu\text{m}$  fiber-optic cables. All three connectors are adapters that can be easily changed or removed for cleaning. Simply unscrew each adapter in a counterclockwise direction. Useful measurements are achievable with other adapters, but measurement performance may not be optimum. Refer to "Front-Panel Fiber-Optic Adapters" in Chapter 5 for a complete listing of available adapter types.

**Softkeys select  
instrument features**

Many instrument features are available through the use of softkeys. Softkeys are the eight keys that are located along the right-hand side of the display. The definitions for these keys are shown on the display next to the key and change for different menus.

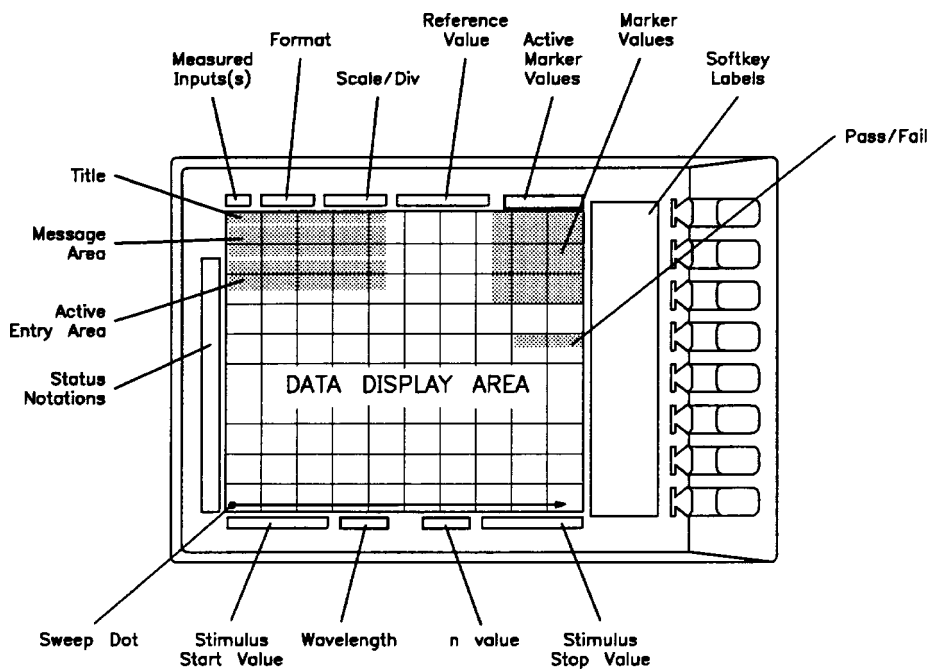

### Annotation Shown in the Display's "Status Notation" Area

Status Notations	Description
*	Measurement parameters changed: measured data is in doubt until a complete clean sweep has been taken.
Avg	Sweep-to-sweep averaging is on. The averaging count is shown immediately below this notation.
C	Error correction (measurement calibration) is on.
D	Dispersion correction is on. This notation is available for the 1550 nm source only.
ext	Waiting for an external trigger at the rear panel.
Hld	Hold sweep.
OVL	Amplitude of reflected signal at test port is too large.

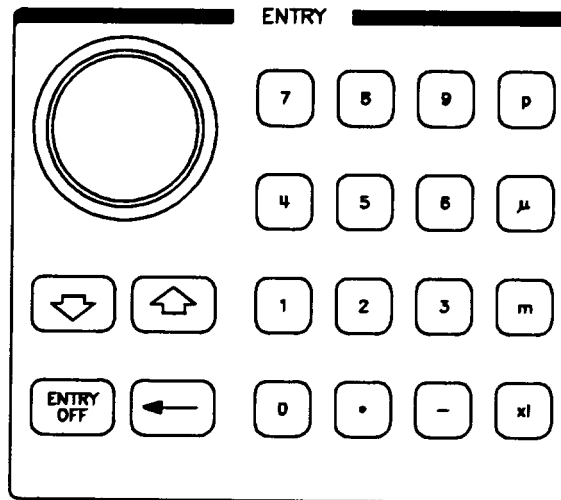

front-panel knob Allows continuous adjustments to current values for various functions such as start value, scale, and others. Values changed by the knob are effective immediately, and require no units terminator.

**G/n**

Terminates numeric keypad entries with  $10^{\pm 9}$  multiplier.

**M/μ**

Terminates numeric keypad entries with  $10^{\pm 6}$  multiplier.

**k/m**

Terminates numeric keypad entries with  $10^{\pm 3}$  multiplier.

**x1**

Terminates unitless entries such as averaging factors.

**ENTRY OFF**

Disables the keypad, knob, and step keys until another function is selected.



### **Keys in this manual**

**boxed** letters indicate normal front-panel keys. Most of these functions also can be performed using softkeys.

**shadow** letters indicate softkeys.

---

# Safety Symbols

The following safety symbols are used throughout this manual. Familiarize yourself with each of the symbols and its meaning before operating this instrument.

---

## CAUTION

---

The *caution* sign denotes a hazard to the instrument. It calls attention to a procedure which, if not correctly performed or adhered to, could result in damage to or destruction of the instrument. Do not proceed beyond a *caution* sign until the indicated conditions are fully understood and met.

---

## WARNING

---

The *warning* sign denotes a life-threatening hazard. It calls attention to a procedure which, if not correctly performed or adhered to, could result in injury or loss of life. Do not proceed beyond a *warning* sign until the indicated conditions are fully understood and met.

---

### Instruction Manual



The **instruction manual** symbol. The product is marked with this symbol when it is necessary for the user to refer to the instructions in the manual.



The line-power on symbol.



The line-power off symbol.

---

CE

The CE mark is a registered trademark of the European Community. [If accompanied by a year, it is when the design was proven.]

---

ISM1-A

This is a symbol of an Industrial Scientific and Medical Group 1 Class A product.

---

CSA

The CSA mark is a registered trademark of the Canadian Standards Association.

---

---

# Certification and Assistance

Hewlett-Packard Company certifies that this product met its published specifications at the time of shipment from the factory. Hewlett-Packard further certifies that its calibration measurements are traceable to the United States National Institute of Standards and Technology (NIST), to the extent allowed by the Institute's calibration facility, and to the calibration facilities of other International Standards Organization members.

*Product maintenance agreements and other customer assistance agreements are available for Hewlett-Packard products.*

*For any assistance, contact your nearest Hewlett-Packard Sales and Service Office.*

---

# Warranty

This Hewlett-Packard instrument product is warranted against defects in material and workmanship for a period of one year from date of shipment. During the warranty period, Hewlett-Packard Company will, at its option, either repair or replace products which prove to be defective.

For warranty service or repair, this product must be returned to a service facility designated by Hewlett-Packard. Buyer shall prepay shipping charges to Hewlett-Packard and Hewlett-Packard shall pay shipping charges to return the product to Buyer. However, Buyer shall pay all shipping charges, duties, and taxes for products returned to Hewlett-Packard from another country.

Hewlett-Packard warrants that its software and firmware designated by Hewlett-Packard for use with an instrument will execute its programming instructions when properly installed on that instrument. Hewlett-Packard does not warrant that the operation of the instrument, or software, or firmware will be uninterrupted or error-free. **LIMITATION OF WARRANTY**

The foregoing warranty shall not apply to defects resulting from improper or inadequate maintenance by Buyer, Buyer-supplied software or interfacing, unauthorized modification or misuse, operation outside of the environmental specifications for the product, or improper site preparation or maintenance.

**NO OTHER WARRANTY IS EXPRESSED OR IMPLIED. HEWLETT-PACKARD SPECIFICALLY DISCLAIMS THE IMPLIED WARRANTIES OF MERCHANTABILITY AND FITNESS FOR A PARTICULAR PURPOSE.**

## **EXCLUSIVE REMEDIES**

**THE REMEDIES PROVIDED HEREIN ARE BUYER'S SOLE AND EXCLUSIVE REMEDIES. HEWLETT-PACKARD SHALL NOT BE LIABLE FOR ANY DIRECT, INDIRECT, SPECIAL, INCIDENTAL, OR CONSEQUENTIAL DAMAGES, WHETHER BASED ON CONTRACT, TORT, OR ANY OTHER LEGAL THEORY.**

---

# Contents

<b>1. Installing</b>	
Step 1. Inspect the shipment . . . . .	1-4
Step 2. Connect the two instrument sections . . . . .	1-6
Step 3. Set the line voltage . . . . .	1-8
Step 4. Connect the rear-panel cables . . . . .	1-11
Step 5. Verify Operation . . . . .	1-12
To replace the line fuse . . . . .	1-20
Cleaning Connections for Accurate Measurements . . . . .	1-22
To clean a non-lensed connector . . . . .	1-24
To clean an adapter . . . . .	1-25
To test insertion loss . . . . .	1-25
To test return loss . . . . .	1-26
Returning Your Instrument . . . . .	1-27
To return the instrument for service . . . . .	1-28
<b>2. Performing Guided Setups and Calibrations</b>	
Running Guided Setups and Calibrations . . . . .	2-6
To perform a guided setup (devices with pigtail) . . . . .	2-7
To perform a guided setup (devices without pigtail) . . . . .	2-13
To perform a guided calibration . . . . .	2-18
Performing Manual Calibrations . . . . .	2-20
To balance the receiver . . . . .	2-23
To calibrate the magnitude . . . . .	2-25
To calibrate for an external source . . . . .	2-26
To turn off calibration data . . . . .	2-28
To enter the standard's reflection percentage . . . . .	2-28
To turn chromatic dispersion correction on and off . . . . .	2-28
To use the Option 001 cable tray . . . . .	2-29
<b>3. Performing Measurements</b>	
Setting the Measurement Range . . . . .	3-4
To select the source wavelength . . . . .	3-6
To automatically tune to a response . . . . .	3-7
To change the displayed scale . . . . .	3-7
To change the refractive index . . . . .	3-8
Reducing Displayed Noise . . . . .	3-9

To reduce the displayed noise . . . . .	3-11
Using Markers . . . . .	3-12
To display a peak response . . . . .	3-16
To change the measurement range . . . . .	3-16
To make relative measurements . . . . .	3-16
To position a fixed reference marker . . . . .	3-17
To change the peak definition . . . . .	3-17
To turn markers off . . . . .	3-18
Creating Limit Lines . . . . .	3-19
To enter limit-line segments . . . . .	3-23
To display or hide limit lines . . . . .	3-23
To turn on limit testing . . . . .	3-24
Tutorial: Using Limit Lines . . . . .	3-25
Storing Traces to Memory . . . . .	3-34
To view memory traces . . . . .	3-35
Saving Instrument States to Registers . . . . .	3-36
To save to a register . . . . .	3-38
To recall a register . . . . .	3-38
To increase user memory . . . . .	3-39
Saving Instrument States to Files . . . . .	3-40
To save to a disk . . . . .	3-41
To change a file name . . . . .	3-42
To recall an external file . . . . .	3-43
To delete an external file . . . . .	3-43
To format an external disk . . . . .	3-43
To connect a disk drive . . . . .	3-44
Changing Colors and Audible Warnings . . . . .	3-45
To adjust displayed colors . . . . .	3-45
To turn on the warning beep . . . . .	3-45
To turn off the “done” beep . . . . .	3-46
Printing and Plotting . . . . .	3-47
To print the display . . . . .	3-48
To plot the display . . . . .	3-48
To print or plot measurement and parameter values . . . . .	3-49
To enter the printer/plotter type and address . . . . .	3-49
To abort a print or plot . . . . .	3-50

<b>4. Programming</b>	
Controlling the Instrument . . . . .	4-4
To select the HP-IB mode . . . . .	4-8
To change the HP-IB address . . . . .	4-8
Monitoring the Instrument . . . . .	4-9
IEEE 488.2 Common Commands . . . . .	4-12
Instrument Commands . . . . .	4-15
Keys versus Commands . . . . .	4-54
<b>5. Reference</b>	
Menu Maps . . . . .	5-3
Keys, Softkeys, and Connectors . . . . .	5-11
Block Diagram . . . . .	5-53
Front-Panel Fiber-Optic Adapters . . . . .	5-54
Part Numbers . . . . .	5-55
Instrument Options . . . . .	5-56
Line-Power Cables . . . . .	5-57
<b>6. Specifications and Regulatory Information</b>	
Specifications . . . . .	6-4
LED Classification . . . . .	6-4
Return Loss Measurement Range . . . . .	6-5
Return Loss Uncertainty . . . . .	6-6
Sweep-to-Sweep Repeatability . . . . .	6-8
Two-Event Spatial Accuracy . . . . .	6-9
Two-Event Spatial Resolution . . . . .	6-10
Spurious Responses . . . . .	6-12
Characteristics . . . . .	6-14
Regulatory Information . . . . .	6-16
Notice for Germany: Noise Declaration . . . . .	6-16
<b>7. Error Messages</b>	
Message Definitions . . . . .	7-3
Error Message Numbers . . . . .	7-11

**Index**

## Contents

---





Installing

---

# Installing

This chapter shows you how to install your precision reflectometer and how to verify that it is operating properly. Be sure to save the shipping containers in the event that the instrument should need to be returned to HP. It is important to have the correct packaging.

Refer to Chapter 6 for information on operating conditions such as temperature.

If you should ever need to clean the cabinet, use a damp cloth only.

---

**WARNING**

---

For continued protection against fire hazard, replace line fuse only with same type and ratings. The use of other fuses or materials is prohibited. The correct fuse types are listed on the rear panel of each instrument section.

---

**WARNING**

---

If this product is to be energized via an external autotransformer for voltage reduction, make sure that its common terminal is connected to a neutral (earthed pole) of the power supply.

---

**CAUTION**

---

When installing the product in a cabinet, the convection into and out of the product must not be restricted. The ambient temperature (outside the cabinet) must be less than the maximum operating temperature of the product by 4°C for every 100 watts dissipated in the cabinet. If the total power dissipated in the cabinet is greater than 800 watts, then forced convection must be used.

---

**CAUTION**

---

This product is designed for use in INSTALLATION CATEGORY II and POLLUTION DEGREE 2, per IEC 1010 and 664 respectively.

**Contents**

Step 1. Inspect the shipment .....	1-4
Step 2. Connect the two instrument sections .....	1-6
Step 3. Set the line voltage .....	1-8
Step 4. Connect the rear-panel cables .....	1-11
Step 5. Verify Operation .....	1-12
To replace the line fuse .....	1-20
Cleaning Connections for Accurate Measurements .....	1-22
To clean a non-lensed connector .....	1-24
To clean an adapter .....	1-25
To test insertion loss .....	1-25
To test return loss .....	1-26
Returning Your Instrument .....	1-27
To return the instrument for service .....	1-28

---

## Step 1. Inspect the shipment

- Verify that all system components ordered have arrived by comparing the shipping forms to the original system purchase order. Inspect all shipping containers.

If your shipment is damaged or incomplete, save the packing materials and notify both the shipping carrier and the nearest Hewlett-Packard sales and service office. HP will arrange for repair or replacement of damaged or incomplete shipments without waiting for a settlement from the transportation company. Notify the HP customer engineer of any problems.

**Precision Reflectometer Accessories**

<b>Item</b>	<b>Quantity</b>
<b>Standard:</b>	
Wood box	1
100 cm FC/PC fiber-optic cable	2
Fiber-optic cable adapter <sup>1</sup>	1
Low-reflection termination	1
Isopropyl alcohol cleaner (30 ml)	1
Cotton swabs	1
Tape measure (3 m)	1
Rear-panel BNC cable	1
Rear-panel IO INTERCONNECT cable	1
Rear-panel line-power cable	1
<b>Option 001 Accessory Kit:</b>	
Cable tray	1
Fiber-optic cable adapter <sup>1</sup>	1
40 cm FC/PC fiber-optic cable	2
50 cm FC/PC fiber-optic cable	2
75 cm FC/PC fiber-optic cable	2
125 cm FC/PC fiber-optic cable	2
150 cm FC/PC fiber-optic cable	2
175 cm FC/PC fiber-optic cable	2

<sup>1</sup> Used to connect two FC/PC fiber-optic cables.

---

## Step 2. Connect the two instrument sections

---

### WARNING

---

Always disconnect and separate the two instrument sections before lifting or moving the instrument. Otherwise, you may harm yourself or damage the instrument.

1. Verify that serial number labels on the two instrument sections contain the same serial number. You'll find these labels on the precision reflectometer's rear panel. Make sure that the serial number and options listed on the labels match the serial number and options listed on the shipping document.
2. Place the lightwave section on a steady, sturdy work surface.
3. Place the display processor on top of the lightwave section so that the front edge of the display processor is about 0.6 cm (0.25 in) in front of the lightwave section.

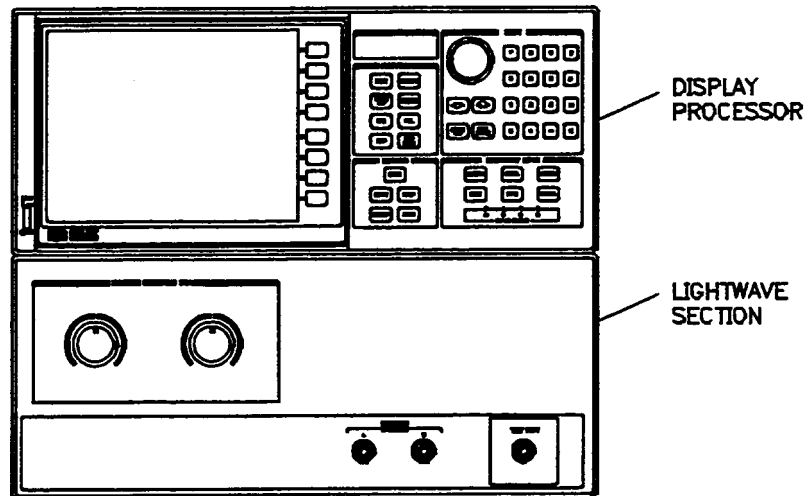

4. Slightly lift the rear of the display processor and slide it back until its front edge is even with the front edge of the lightwave section.

**Step 2. Connect the two instrument sections**

Hooks on the top of the lightwave section will slide into slots on the display processor and lock the front panels of the two sections together.

5. Confirm that the two instruments are locked together by very gently lifting up on the front of the display processor. If the display processor separates from the lightwave section, they are not locked together properly.
6. Tighten the rear-panel thumbscrews on the locking feet.

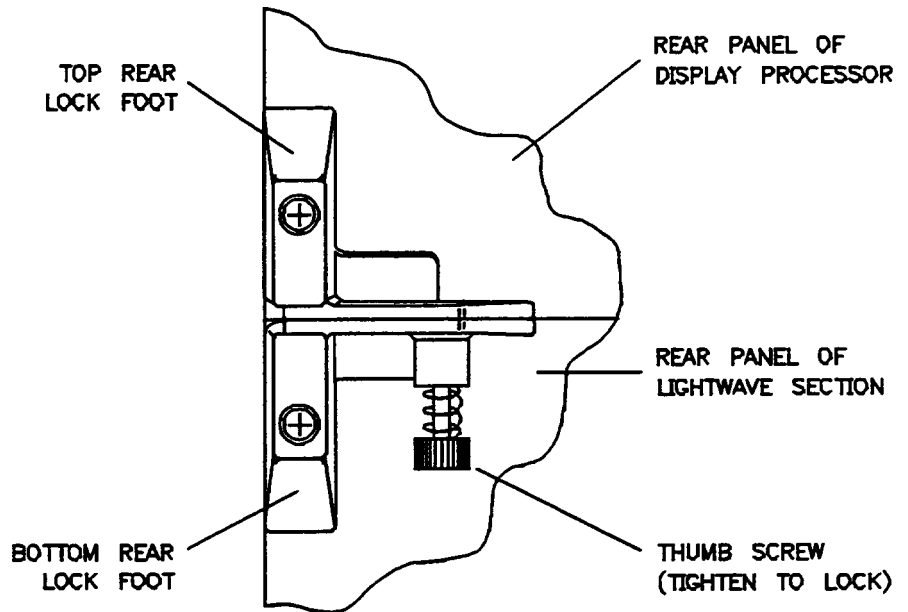

7. Ensure that there is a minimum of seven centimeters (three inches) free space around the instrument to provide for adequate cooling.

---

## Step 3. Set the line voltage

---

### CAUTION

---

Severe damage to the instrument can result if line voltage settings are incorrect when power is applied.

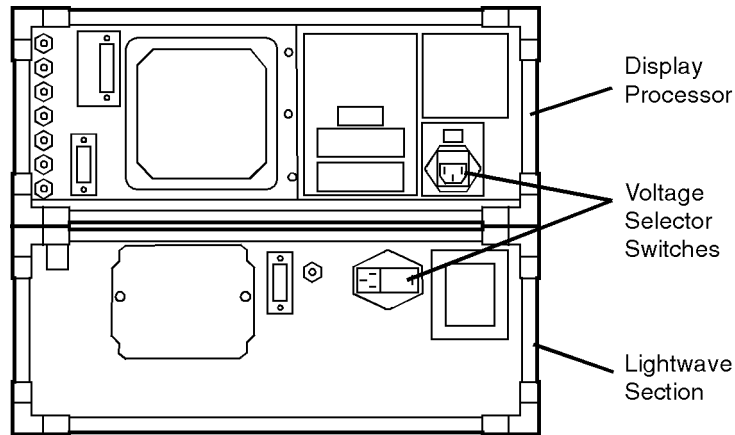

kent1s

1. Determine the line voltage of the AC power source. The line-power cords should not be connected to the precision reflectometer at this time.
2. Use a small flat-blade screwdriver to set the display processor's line-voltage selector switch to the value determined in step 1.
3. Use a small flat-blade screwdriver to open the display processor's pull-out fuse drawer. See the following figure.



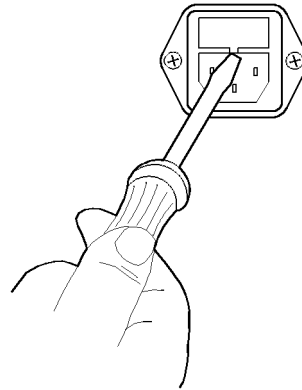

fusedr

4. Verify that the value of the line-voltage fuse in the pull-out drawer is correct. The recommended fuse for both line-switch settings is a F3.0A, 250V, HP part number 2110-0780.

Notice that an extra fuse is provided in a drawer located on the fuse holder.

5. On the lightwave section, use a flat-blade screwdriver to pry open the line module cover door. The cover door is hinged on the left side. Pry beneath the tag that is located along the cover door's right-side edge. See the following figure

**Step 3. Set the line voltage**

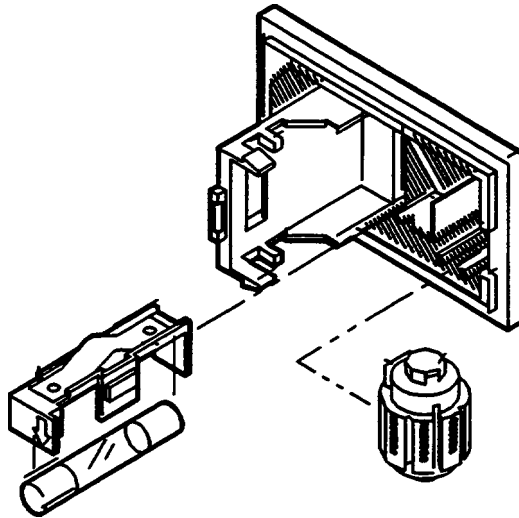

---

**CAUTION**

---

Do not attempt to rotate the voltage selector cam while it is installed in the line module or non-repairable damage will result. The cam must be completely removed from the line module, rotated to the proper position, and reinstalled.

6. Remove the voltage selector cam from the line module.
7. Rotate the voltage selector cam to the desired voltage. When the line module cover is closed, the selected voltage will be visible through a small window.
8. Insert the voltage selector cam back into the line module.
9. Verify that the value of the line-voltage fuse in the pull out draw is correct.

The recommended fuse for 100V and 120V operation is a F1.5A, 250V, HP part number 2110-0043. The recommended fuse for 220V and 240V operation is a F0.75A, 250V, HP part number 2110-0063.

10. Close the line-module cover door.

---

## Step 4. Connect the rear-panel cables

---

### WARNING

This is a Safety Class 1 Product (provided with a protective earthing ground incorporated in the power cord). The mains plug shall only be inserted in a socket outlet provided with a protective earth contact. Any interruption of the protective conductor inside or outside of the instrument is likely to make the instrument dangerous. Intentional interruption is prohibited.

---

### CAUTION

Always use the three-prong AC power cord supplied with this instrument. Failure to ensure adequate earth grounding by not using this cord may cause instrument damage.

1. Connect the I/O interconnect cable between the display processor and the lightwave section.
2. Connect the BNC cable between the display processor and the lightwave section.
3. Connect the power cable to display processor and the lightwave section.

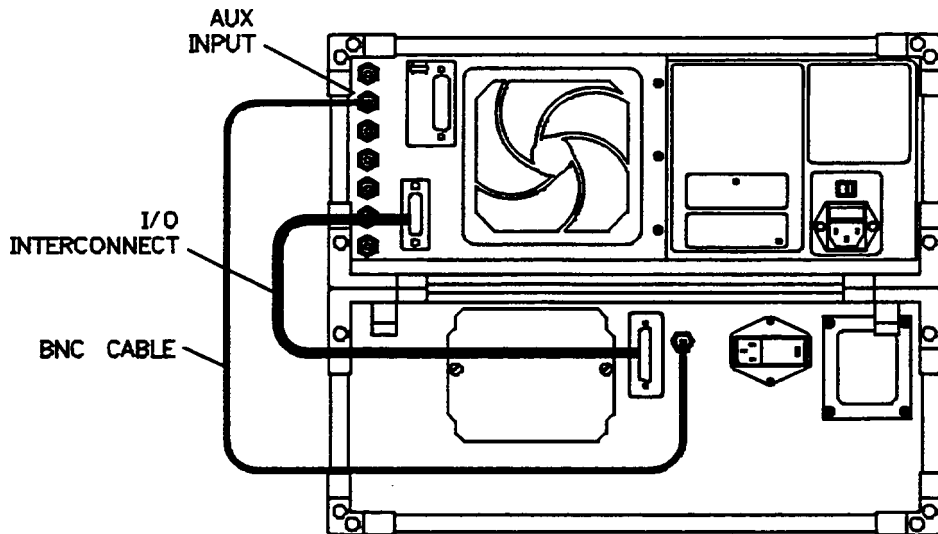

---

## Step 5. Verify Operation

This step takes approximately 20 minutes to complete.

### Equipment Required

The following equipment is supplied with the precision reflectometer.

- Two 100 cm FC/PC fiber-optic cables.
- One fiber-optic cable coupling adapter.
- One low-reflection fiber-optic termination.

#### **Tighten connectors properly**

Over-tightening or under-tightening connectors can result in misalignment and nonrepeatable measurements. Always finger tighten connectors in a consistent manner. Refer to the manufacturer's data sheet for any torque recommendations.

1. Turn the precision reflectometer on, and allow it to warm up for at least one hour.
2. Clean all cable connectors and front-panel optical ports.

Refer to "Cleaning Connections for Accurate Measurements" for information on cleaning connectors.

3. Attach one of the 100 cm fiber-optic cables to the front-panel **TEST PORT** connector.

When mating Super PC connectors, check to see that the keyways on the Super PC cable connectors are inserted into the slots on the mating connectors.

4. If there is a protective cap on the free end of the fiber-optic cable, remove it.
5. Attach the other 100 cm fiber-optic cable between the front-panel **REFERENCE EXTENSION** connectors **A** and **B**.

The **REFERENCE EXTENSION** and **TEST PORT** fiber-optic cables must be equal in length in order for reflections to be viewed on the display.

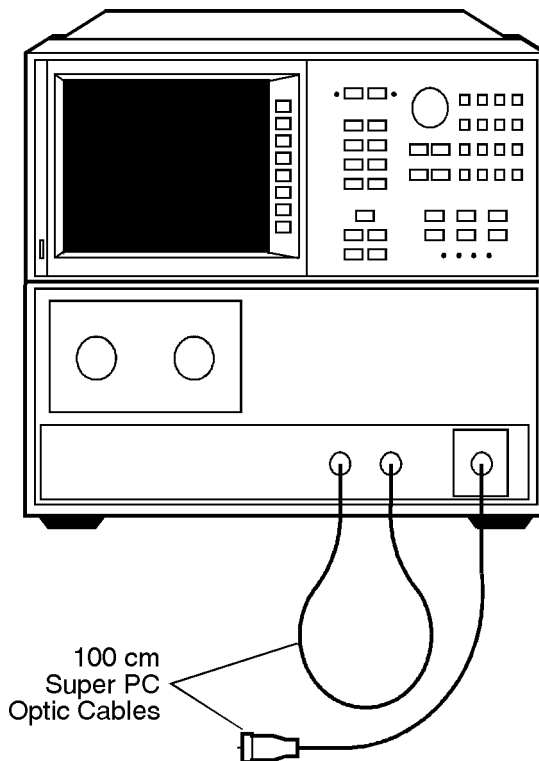

kent2s

6. Press **PRESET**.

The wavelength defaults to 1300 nm.

**NOTE**

Do not move the reference extension cable for the rest of this procedure. Any movement of this cable will change the reference signal polarization and will invalidate the calibration.

**Step 5. Verify Operation**

7. Press **CAL** and then **GUIDED CAL**.
8. Use the supplied adapter to connect the low-reflection termination to the open end of the **TEST PORT** cable.

Do not connect the termination to the front-panel connector as suggested on the screen.



**Low Reflection Termination**

9. Adjust the two front-panel **REFERENCE POLARIZATION BALANCE** knobs until the line is in the shaded area. See the following figure.

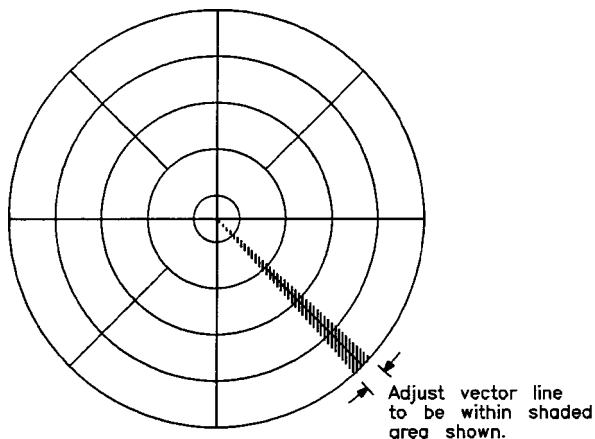

10. Press **DONE**.
11. Disconnect the low-reflection termination from the fiber-optic cable.
12. Press **FRESNEL** and then **MEASURE STANDARD**.  
The end of the cable is providing a Fresnel standard.
13. Wait until the asterisk on the display's left-hand side disappears and the letter **C** remains below the asterisk.

14. You should see a Fresnel response on the display due to a reflection from the end of the test port cable. If the response is missing, check the following, and repeat this procedure from the beginning:
- Are the the front-panel cables properly connected?
  - Are the rear-panel cables attached to the correct connectors?

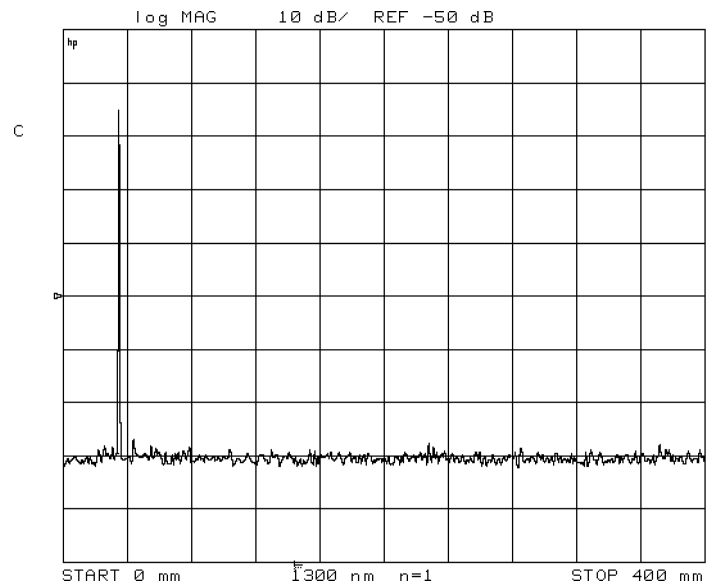

**Fresnel response.**

15. Press **(MKR FCTN)**, **MAX SEARCH**, and then **MKR ZOOM**.

This expands the display around the Fresnel response. Wait for the response to move to the center of the display.

16. Press **MAX SEARCH**, and read the marker's amplitude value on the display. If the value is not within the values shown below, thoroughly clean all connectors on the cables and front panel, and repeat this procedure from step 1.

Peak value (1300 nm source) ..... -15 dB  $\pm$ 0.5 dB  
 Peak value (1550 nm source) ..... -14.7 dB  $\pm$ 0.5 dB

**Step 5. Verify Operation**

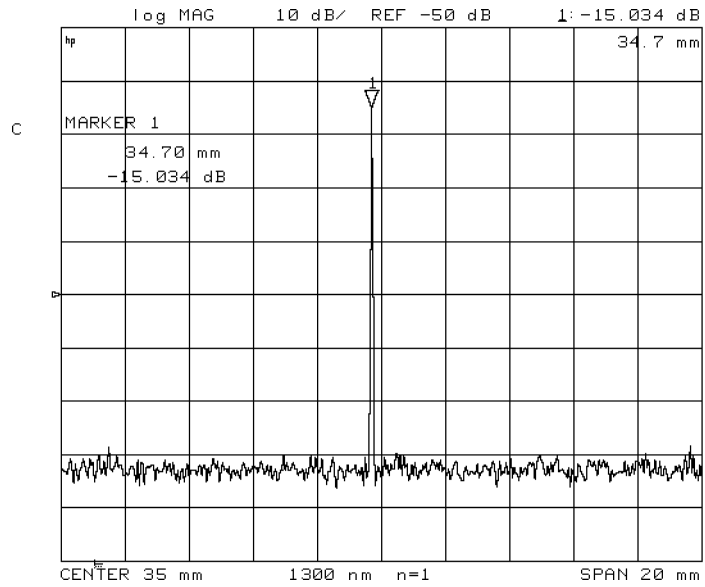

**Marker showing peak value with 1300 nm source.**

17. Connect a coupling adapter to the end of the TEST PORT fiber-optic cable.



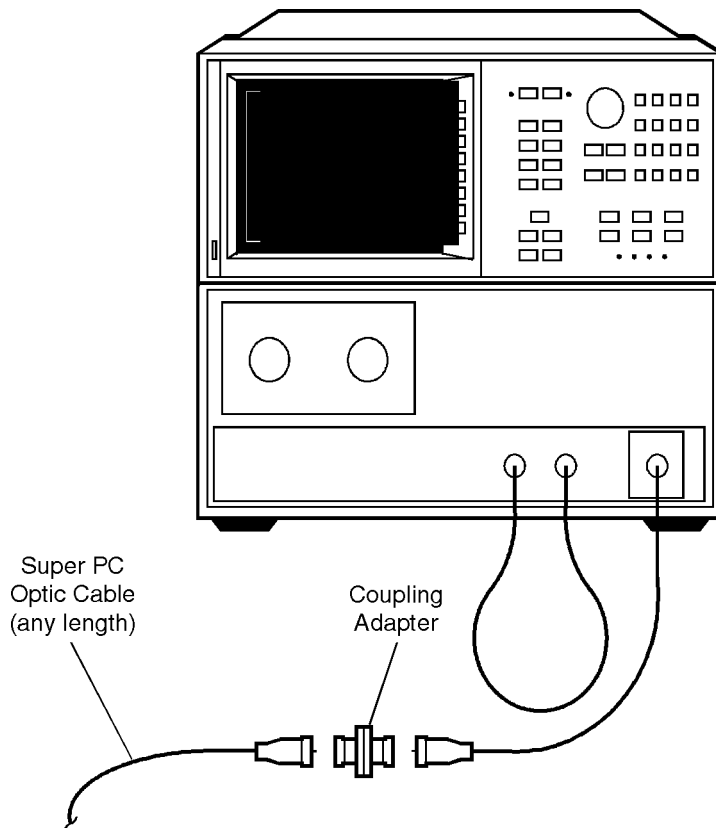

kent3s

18. Partially insert the connector of another cable into the adapter. Observe the Fresnel reflection of this connector as you insert the cable.
19. Repeatedly press **MKR ZOOM** as you slowly insert the connector into the adapter until the span is 1 mm. The Fresnel response should be as close to the original response as possible and can still be resolved. See the following figure.

**Step 5. Verify Operation**

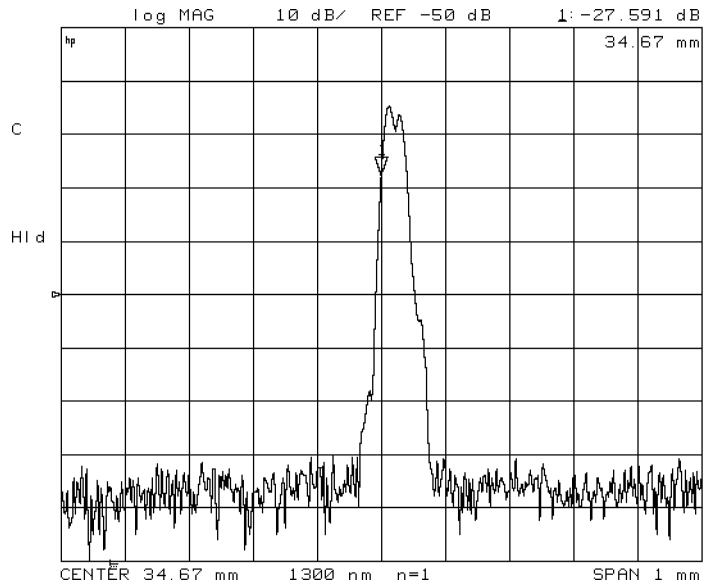

**Two responses viewed as a single signal.**

20. Press **MEAS** and then **TRIGGER:HOLD** to freeze the trace.
21. Press **MKR FCTN**, **MAX SEARCH**, and then **MARKER → FIXED MKR** to turn on the delta marker and to reference the fixed marker to zero on one of the peaks.
22. Turn the front-panel knob to center the marker on the other peak.
23. The displayed spatial resolution shown in the marker area should be less than the following values:

1300 nm source	.....	0.025 mm
1550 nm source	.....	0.25 mm

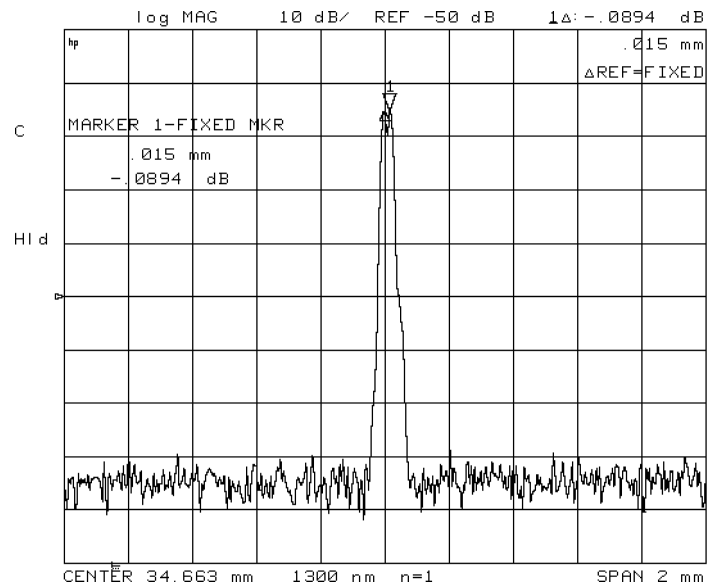

**Delta marker showing spatial resolution.**

24. Press **PRESET**.
25. Press **MENU** and then **1550 nm**.
26. Remove the coupling adapter from the fiber-optic cable, and repeat this procedure from step 7 to check the operation at 1550 nm.

---

## To replace the line fuse

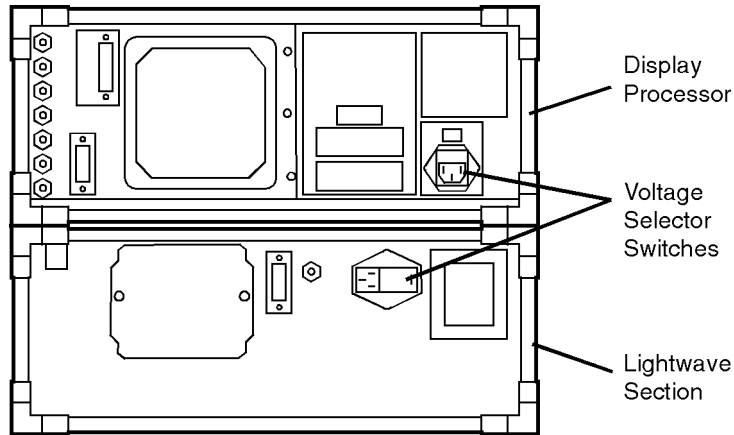

kent1s

- To change the fuse on the display processor section:
  1. Disconnect the line-power cord from the display processor section.
  2. Use a small flat-blade screwdriver to open the pull-out fuse drawer as shown in the following figure.

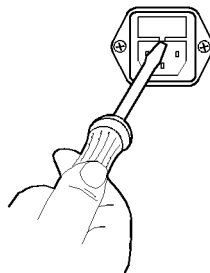

fusedr

3. The recommended fuse for both line-switch settings is a F3.0A, 250V, HP part number 2110-0780.

Notice that an extra fuse is provided in a drawer located on the fuse holder.

- To change the fuse on the lightwave section:
  1. Disconnect the line-power cord from the lightwave section.
  2. On the lightwave section, use a flat-blade screwdriver to pry open the line-module cover door. The cover door is hinged on the left side. Pry beneath the tag that is located along the cover door's right-side edge. See the following figure.

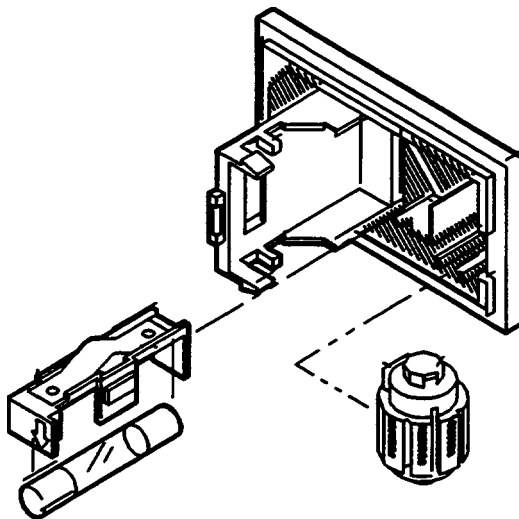

3. Pull out the fuse drawer. The following list shows the recommended fuse:

100V and 120V operation .....	F1.5A 250V (HP p/n 2110-0043)
220V and 240V operation .....	F0.75A 250V (HP p/n 2110-0063)

---

# Cleaning Connections for Accurate Measurements

Accurate and repeatable measurements require clean connections. Use the following guidelines to achieve the best possible performance when making measurements on a fiber-optic system:

- Keep connectors covered when not in use.
- Use dry connections whenever possible.
- Use the cleaning methods described in this section.
- Use care in handling all fiber-optic connectors.
- When inserting a fiber-optic connector into a front-panel adapter, make sure that the fiber end does not touch the outside of the mating connector or adapter.

Because of the small size of cores used in optical fibers, care must be used to ensure good connections. Poor connections result from core misalignment, air gaps, damaged fiber ends, contamination, and improper use and removal of index-matching compounds.

Use dry connections. Dry connectors are easier to clean and to keep clean. Dry connections can be used with physically contacting connectors (for example, Diamond HMS-10/HP, FC/PC, DIN, and ST). If a dry connection has 40 dB return loss or better, making a wet connection will probably not improve (and can degrade) performance.

---

## CAUTION

Hewlett-Packard strongly recommends that index matching compounds NOT be applied to their instruments and accessories. Some compounds, such as gels, may be difficult to remove and can contain damaging particulates. If you think the use of such compounds is necessary, refer to the compound manufacturer for information on application and cleaning procedures.

---

### Cleaning Accessories

Item	HP Part Number
Isopropyl alcohol	8500-5344
Cotton swabs	8520-0023
Small foam swabs	9300-1223
Compressed dust remover (non-residue)	8500-5262

**Dust Caps Provided with Lightwave Instruments**

Item	HP Part Number
Laser shutter cap	08145-64521
FC/PC dust cap	08154-44102
Biconic dust cap	08154-44105
DIN dust cap	5040-9364
HMS10/HP dust cap	5040-9361
ST dust cap	5040-9366

**Inspecting Fiber-Optic Cables**

Consistent measurements with your lightwave equipment are a good indication that you have good connections. However, you may wish to know the insertion loss and/or return loss of your lightwave cables or accessories. If you test your cables and accessories for insertion loss and return loss upon receipt, and retain the measured data for comparison, you will be able to tell in the future if any degradation has occurred.

Connector (or insertion) loss is one important performance characteristic of a lightwave connector. Typical values are less than 1 dB of loss, and sometimes as little as 0.1 dB of loss with high performance connectors. Return loss is another important factor. It is a measure of reflection: the less reflection the better (the larger the return loss, the smaller the reflection). The best physically contacting connectors have return losses better than 50 dB, although 30 to 40 dB is more common.

**You can visually inspect your cables**

Although it is not necessary, visual inspection of fiber ends can be helpful. Contamination or imperfections on the cable end face can be detected as well as cracks or chips in the fiber itself. Use a microscope (100X to 200X magnification) to inspect the entire end face for contamination, raised metal, or dents in the metal as well as any other imperfections. Inspect the fiber for cracks and chips. Visible imperfections not touching the fiber core may not affect performance (unless the imperfections keep the fibers from contacting).

## To clean a non-lensed connector

---

**CAUTION**

---

Do not use any type of foam swab to clean optical fiber ends. Foam swabs can leave filmy deposits on fiber ends that can degrade performance.

1. Apply isopropyl alcohol to a clean lint-free cotton swab or lens paper.  
Cotton swabs can be used as long as no cotton fibers remain on the fiber end after cleaning.
2. Before cleaning the fiber end, clean the ferrules and other parts of the connector.
3. Apply isopropyl alcohol to a new clean lint-free cotton swab or lens paper.
4. Clean the fiber end with the swab or lens paper. Move the swab or lens paper back and forth across the fiber end several times.  
Some amount of wiping or mild scrubbing of the fiber end can help remove particles when application of alcohol alone will not remove them. This technique can remove or displace particles smaller than one micron.
5. Immediately dry the fiber end with a clean, dry, lint-free cotton swab or lens paper.
6. Blow across the connector end face from a distance of 6 to 8 inches using filtered, dry, compressed air. Aim the compressed gas at a shallow angle to the fiber end face.

Nitrogen gas or compressed dust remover can also be used.

---

**CAUTION**

---

Do not shake, tip, or invert compressed air canisters, because this releases particles in the can into the air. Refer to instructions provided on the compressed air canister.

7. As soon as the connector is dry, connect or cover it for later use.



---

## To clean an adapter

1. Apply isopropyl alcohol to a clean foam swab.

Cotton swabs can be used as long as no cotton fibers remain after cleaning. The foam swabs listed in this section's introduction are small enough to fit into adapters.

Although foam swabs can leave filmy deposits, these deposits are very thin, and the risk of other contamination buildup on the inside of adapters greatly outweighs the risk of contamination by foam swabs.

2. Clean the adapter with the foam swab.
3. Dry the inside of the adapter with a clean, dry, foam swab.
4. Blow through the adapter using filtered, dry, compressed air.

Nitrogen gas or compressed dust remover can also be used.

---

### **CAUTION**

Do not shake, tip, or invert compressed air canisters, because this releases particles in the can into the air. Refer to instructions provided on the compressed air canister.

---

---

## To test insertion loss

Use an appropriate lightwave source and a compatible lightwave receiver to test insertion loss. Examples of test equipment configurations include the following equipment:

- HP 71450A or HP 71451A optical spectrum analyzers with Option 002 built-in white light source.
- HP 8702 or HP 8703 lightwave component analyzer system
- HP 83420 lightwave test set with an HP 8510 network analyzer
- HP 8153 lightwave multimeter with a source and power sensor module

## To test return loss

Use an appropriate lightwave source, lightwave receiver, and lightwave coupler to test return loss. Examples of test equipment configurations include the following equipment:

- HP 8703 lightwave component analyzer
- HP 8702 analyzer with the appropriate source, receiver, and lightwave coupler
- HP 8504 precision reflectometer
- HP 8153 lightwave multimeter with a source and power sensor module in conjunction with a lightwave coupler
- HP 81554SM dual source and HP 81534A return loss module

---

## Returning Your Instrument

It is unlikely that your precision reflectometer should need to be returned to the Hewlett Packard. However, if you do need to return it, repackage the instrument using the original shipping containers and materials or their equivalents. Hewlett-Packard offices can provide packaging materials identical to the original materials.

---

**CAUTION**

---

Packaging materials not specified can result in instrument damage. Never use styrene pellets to package electronic instruments. The pellets do not adequately cushion the instrument, do not prevent all instrument movement, and can generate static electricity.

## To return the instrument for service

1. Fill out the repair form (located on the next page), and place it in the box with the instrument. Send a copy of any noted error messages or other helpful performance data.
2. To help prevent damage during transit, pack the instrument in the factory packaging materials. Although the original shipping materials or equivalents are best; the following instructions result in acceptable packaging:
  - a. Wrap the instrument in anti-static plastic to reduce the possibility of ESD damage.
  - b. For instruments that weigh less than 54 kg (120 lb), use a double-walled, corrugated cardboard carton of 159 kg (350 lb) test strength. The carton must be both large enough and strong enough to accommodate the instrument. Allow at least three to four inches on all sides of the instrument for packing material.
  - c. Surround the equipment with three to four inches of packing material to protect the module and to prevent movement in the carton. If packing foam is not available, the best alternative is S.D.-240 Air Cap™ from Sealed Air Corporation, Hayward, California 94545. Air Cap is plastic sheeting filled with 1-1/4 inch air bubbles. Use pink anti-static Air Cap. Wrapping the instrument several times in this material should provide sufficient protection and also prevent movement in the carton.
3. Seal the carton with strong nylon adhesive tape.
4. Mark the carton FRAGILE, HANDLE WITH CARE.
5. Retain copies of all shipping papers.

### Service Repair Form

<b>Date:</b>	_____
<b>Company:</b>	_____
<b>Address:</b>	_____ _____ _____
<b>Technical contact person:</b>	_____
<b>Phone:</b>	_____
<b>Model number:</b>	_____
<b>Serial number:</b>	_____
<b>P.O. number:</b>	_____
<b>Accessories returned with unit:</b>	<input type="radio"/> none <input type="radio"/> cables s  <input type="radio"/> power cable <input type="radio"/> adapter s
<b>Other:</b>	_____
<b>Service Needed:</b>	<input type="radio"/> calibration only <input type="radio"/> repair <input type="radio"/> repair and calibration
<b>Other:</b>	_____
<b>Failure symptoms and special control settings:</b>	_____ _____ _____ _____ _____
<b>If unit is part of system, list model number s  of other interconnected instruments:</b>	_____ _____ _____

**Hewlett-Packard Sales and Service Offices**

<b>U.S. FIELD OPERATIONS</b>		
<p><b>Headquarters</b> Hewlett-Packard Company 19320 Pruneridge Avenue Cupertino, CA 95014 U.S.A.  800  752-0900</p> <p><b>Colorado</b> Hewlett-Packard Company 24 Inverness Place, East Englewood, CO 80112  303  649-5000</p> <p><b>New Jersey</b> Hewlett-Packard Company 120 West Century Road Paramus, NJ 07653  201  586-5400</p>	<p><b>California, Northern</b> Hewlett-Packard Company 301 East Evelyn Mountain View, CA 94041  415  694-2000</p> <p><b>Georgia</b> Hewlett-Packard Company 2000 South Park Place Atlanta, GA 30339  404  955-1500</p> <p><b>Texas</b> Hewlett-Packard Company 930 East Campbell Road Richardson, TX 75081  214  231-6101</p>	<p><b>California, Southern</b> Hewlett-Packard Company 1421 South Manhattan Ave. Fullerton, CA 92631  714  999-6700</p> <p><b>Illinois</b> Hewlett-Packard Company 5201 Tollview Drive Rolling Meadows, IL 60008  708  342-2000</p>
<b>EUROPEAN FIELD OPERATIONS</b>		
<p><b>Headquarters</b> Hewlett-Packard S.A. 150, Route du Nant-d'Avril 1217 Meyrin 2/Geneva Switzerland  41 22  780.8111</p> <p><b>Great Britain</b> Hewlett-Packard Ltd. Eskdale Road, Winnersh Triangle Wokingham, Berkshire RG11 5DZ</p>	<p><b>France</b> Hewlett-Packard France 1 Avenue Du Canada Zone D'Activite De Courtaboeuf F-91947 Les Ulis Cedex France  33 1  69 82 60 60</p>	<p><b>Germany</b> Hewlett-Packard GmbH Hewlett-Packard Strasse 61352 Bad Homburg Germany  + 49 6172  16-0</p>

**Hewlett-Packard Sales and Service Offices (continued)****INTERCON FIELD OPERATIONS****Headquarters**

Hewlett-Packard Company  
 3495 Deer Creek Rd.  
 Palo Alto, California 94304-1316  
 |415| 857-5027

**Australia**

Hewlett-Packard Australia Ltd.  
 31-41 Joseph Street  
 Blackburn, Victoria 3130  
 |61 3| 895-2895

**Canada**

Hewlett-Packard Ltd.  
 17500 South Service Road  
 Trans-Canada Highway  
 Kirkland, Quebec H9J 2X8  
 Canada  
 |514| 697-4232

**China**

China Hewlett-Packard Company  
 38 Bei San Huan X1 Road  
 Shuang Yu Shu  
 Hai Dian District  
 Beijing, China  
 |86 1| 256-6888

**Japan**

Yokogawa-Hewlett-Packard Ltd.  
 1-27-15 Yabe, Sagamihara  
 Kanagawa 229, Japan  
 |81 427| 59-1311

**Singapore**

Hewlett-Packard Singapore Ltd.  
 Pte. Ltd.  
 Alexandra PO. Box 87  
 singapore 9115  
 |65| 271-9444

**Taiwan**

Hewlett-Packard Taiwan  
 8th Floor, H-P Building  
 337 Fu Hsing North Road  
 Taipei, Taiwan  
 |886 2| 712-0404





---

## Performing Guided Setups and Calibrations

---

# Performing Guided Setups and Calibrations

This chapter shows you how to perform a *guided setups*, a *guided calibrations*, and manual calibrations. Calibrating the precision reflectometer consists of balancing the receiver and then calibrating the magnitude. These two procedures ensure maximum accuracy for your measurements. They remove DC offsets and polarization sensitivity. They also set a calibrated reference level.

Guided setups not only calibrate the instrument, but they also select the source and display instructions for both pigtailed and non-pigtailed devices. Manually calibrating the instrument is generally faster than using the guided calibration.

Display is  
Calibrated

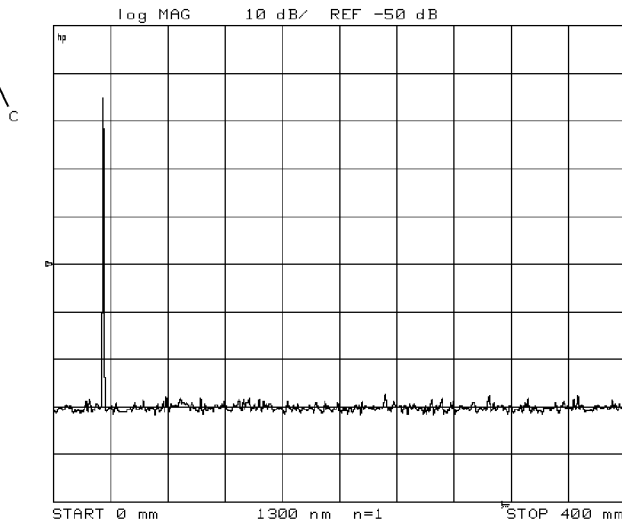

annot

**When the instrument is calibrated, the status indicator C appears on the display's left-hand side.**

**Contents**

Running Guided Setups and Calibrations ..... 2-6  
 To perform a guided setup (devices with pigtail) ..... 2-7  
 To perform a guided setup (devices without pigtail) ..... 2-13  
 To perform a guided calibration ..... 2-18  
 Performing Manual Calibrations ..... 2-20  
 To balance the receiver ..... 2-23  
 To calibrate the magnitude ..... 2-25  
 To calibrate for an external source ..... 2-26  
 To turn off calibration data ..... 2-28  
 To enter the standard's reflection percentage ..... 2-28  
 To turn chromatic dispersion correction on and off ..... 2-28  
 To use the Option 001 cable tray ..... 2-29

**NOTE**

In order to ensure a successful calibration, clean all fiber-optic connectors prior to the calibration. Refer to "Cleaning Connections for Accurate Measurements" in Chapter 1 in this chapter.

**Some hardware is required**

You'll need the following hardware, supplied with HP 8504B, to calibrate the instrument:

- A set of matched-length cables.
- A low-reflection termination.

You can use any termination that has a return loss that is greater than 30 dB.

**Matched-length cables ensure response is visible**

During calibrations and subsequent measurements, two cables must be connected to the precision reflectometer. One cable connects the device being measured to the front-panel **TEST PORT**. The other cable connects the front-panel **REFERENCE EXTENSION A** and **B** connectors. The **REFERENCE EXTENSION** cable must be equal in length (or slightly shorter) than the **TEST PORT** cable.

The relative lengths of these two cables determine the position of the Fresnel reflection (from the end of the **TEST PORT** cable) on the screen. If the **REFERENCE EXTENSION** cable is too long or too short, the measured response may not be visible on the screen. This is shown in the following figure.

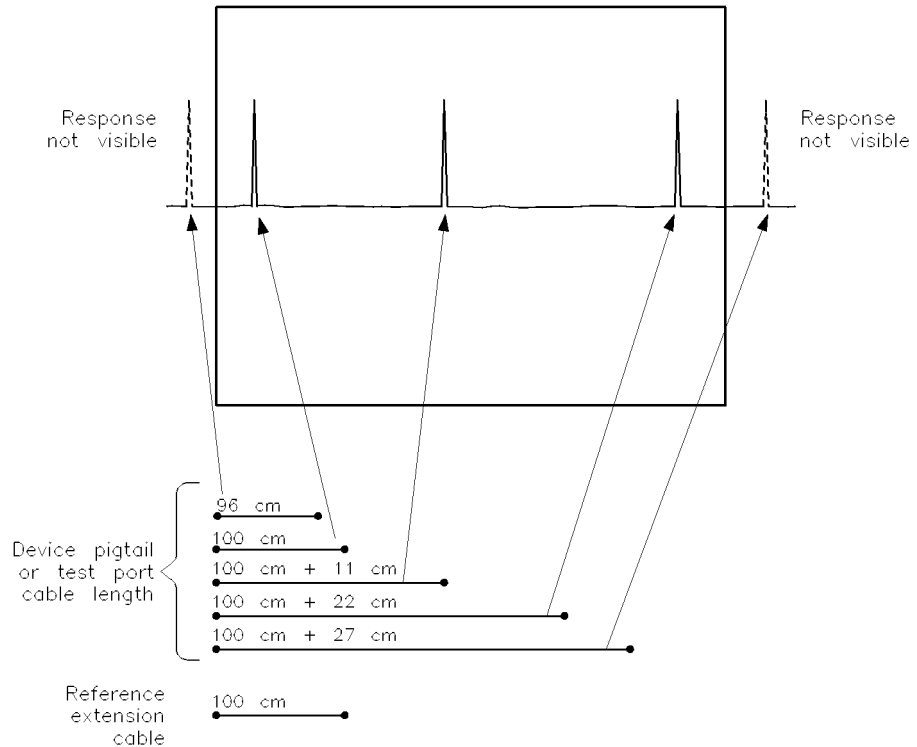

**Cable lengths determine response position.**

**Changing the span does not affect calibrations**

Any calibration performed in less than full span is still valid after the start or stop values are changed. Likewise, a calibration performed in full span is still valid after the start or stop values are changed.

**Keep the reference cable stationary**

Do not move the reference-extension cable connected between **REFERENCE EXTENSION A** and **B** on the front during or after a calibration. Moving this cable changes the polarization and voids the calibration. If you have an Option 001 accessory kit, use the kit's cable tray to help keep the reference extension cable stationary.

Unlike the reference-extension cable, the test-port cable is unaffected by changes in polarization due to cable bending. Therefore, this cable may be moved without degrading the calibration.

**Keep the balance knobs stationary**

Do not move either of the front panel reference-polarization balance knobs after calibration. Moving the knobs compromises the calibration.

---

## Running Guided Setups and Calibrations

This section shows you how to perform *guided setups* for pigtailed or nonpigtailed devices. (A pigtail is a length of fiber-optic cable which usually terminates in a connector.) Guided setups can be started using either the **PRESET** or **SYSTEM** keys. Using the **PRESET** key has the advantage of setting the instrument to a known state.

During a *guided calibration*, a polar vector display shows polarization balance between two receivers in the instrument. After manually adjusting the polarization balance using the front-panel knobs, the precision reflectometer mathematically compensates for any polarization imbalance between the **TEST PORT** cable and the **REFERENCE EXTENSION** paths. To complete the calibration, a standard cable of known reflectance is used to calibrate the magnitude. The displayed response is scaled to match the value specified for the standard in percentage of reflectance.

## To perform a guided setup (devices with pigtail)

1. Press **PRESET** and then **GUIDED SETUP**.
2. Press a softkey to select the wavelength.
3. Press **CLASSIFY DEVICE** and then **PIGTAIL**.

### **Select cables**

4. Press **CONNECT CABLES**.
5. Measure the length of the device's pigtail. Include the length of any additional cable used to connect the device to the front-panel **TEST PORT** connector.
6. Based on the length measured in the preceding step, use the following chart to assemble a fiber-optic cable for the reference path.

**Cable Lengths**

<b>Length of Path for Tested Device<sup>1</sup></b>	<b>Assemble this Cable<sup>2</sup></b>	<b>Length of Path for Tested Device<sup>1</sup></b>	<b>Assemble this Cable<sup>2</sup></b>
40 – 65	40	225 – 250	50 + 175
50 – 75	50	240 – 265	40 + 50 + 150
75 – 100	75	250 – 275	75 + 175
90 – 115	40 + 50	265 – 290	40 + 50 + 175
100 – 125	100	275 – 300	100 + 175
115 – 140	40 + 75	290 – 315	40 + 75 + 175
125 – 150	125	300 – 325	175 + 125
140 – 165	40 + 100	315 – 340	40 + 100 + 175
150 – 175	150	325 – 350	150 + 175
165 – 190	40 + 125	340 – 365	40 + 125 + 175
175 – 200	175	350 – 375	75 + 100 + 175
190 – 215	40 + 150	365 – 390	40 + 150 + 175
200 – 225	50 + 150	375 – 400	50 + 150 + 175
215 – 240	40 + 175		

<sup>1</sup> Lengths are in centimeters.

<sup>2</sup> Standard length cables from Option 001 accessory kit. Lengths are in centimeters.

7. Connect the cables assembled in the preceding step between front-panel **REFERENCE EXTENSION** connectors **A** and **B**.

If you have an Option 001 accessory kit, you can stabilize the cable with the cable tray. Coil the cable around as necessary. If you are using more than one cable, place the mid-connectors in the wide part of the slot. Let the ends of the cable protrude from the tray. Be sure to place the cover on the tray.

8. Connect your device to the front-panel **TEST PORT**.

**Check setup**

9. Press **CHECK SETUP**.

10. Wait for one full measurement sweep to complete.



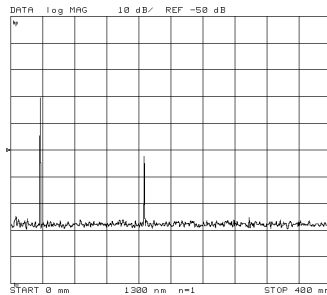

11. If a response is not visible, perform the following steps:
  - a. Press **CAL**, **CALIBRATE MENU**, and then **BALANCE RECEIVER**.
  - b. Follow the prompts on the screen. Then press **DONE**.
  - c. Wait for one full sweep to complete.
  - d. Press **AVG** and then **AVERAGING ON**.
  - e. Wait for the instrument to average 16 sweeps.

On the left side of the graticule, the **Avg** number will count to 16.
  - f. Press **SYSTEM** and then **GUIDED SETUP**, and follow the prompts on the screen.
12. Press **CONNECT TERMINATION**.
13. Disconnect the device from the **TEST PORT**.

**Connect termination**

14. Connect the low-reflection termination directly to the **TEST PORT**.



**Low Reflection Termination**

15. Press **BALANCE RECEIVER**.

**Balance Receiver**

16. Adjust the two polarization balance knobs until the line is in the shaded area.

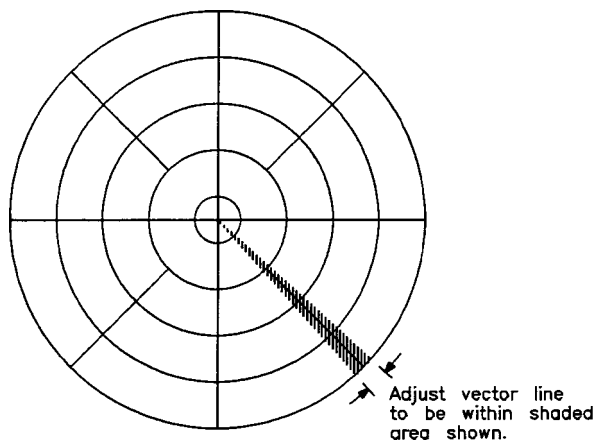

17. Press **DONE**.

**NOTE**

After balancing the receiver, do not move the extension cable, or the balance knobs. Movement degrades measurement accuracy.

**Calibrate Magnitude**

18. Disconnect the termination from the **TEST PORT**.
19. Connect a second cable that is the same length as the **REFERENCE EXTENSION** cable to the **TEST PORT**.

The free end of this cable serves as the “Fresnel” cal standard. When using the supplied cables, the free end of the cable functions as the calibration standard. This is possible because the percentage of light reflected by that type of cable connector is known. (For 1300 nm measurements, the correct value is 3.16%; for 1550 nm, 3.37%.) Other calibration standards (cables, connectors, or devices) may have other reflection values.

20. If you are using cables from the Option 001 accessory kit, press **FRESNEL**. If you are using another standard, perform the following steps:
  - a. Obtain the standard’s reflection return loss (in dB).
  - b. Enter this value using the **USER STD** softkey.
21. Press **MEASURE STANDARD**, and *wait* for the standard to be measured.

**Connect Device Under Test**

22. Disconnect the cable from the **TEST PORT**.
23. Connect the device to be tested to the **TEST PORT**.
24. Press **MEASURE DEVICE** and then **EXIT SETUP** to complete the guided setup and begin device measurements.

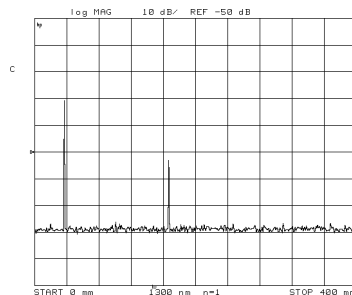

25. As you measure devices, observe the following suggestions:

## Running Guided Setups and Calibrations

- Use the **(START)** and **(STOP)**, **(CENTER)** and **(SPAN)**, and marker keys to optimize the displayed response.

Reducing the span increases measurement speed, improve resolution, and increase dynamic range.

- To improve the signal-to-noise ratio, use averaging. Turn on averaging by pressing **(AVG)** and then **AVERAGING on OFF** so that **ON** is highlighted.

---

## To perform a guided setup (devices without pigtail)

1. Press **PRESET** and then **GUIDED SETUP**.
2. Press a softkey to select the wavelength.
3. Press **CLASSIFY DEVICE** and then **NO PIGTAIL**.

### Select cables

4. Press **CONNECT CABLES**.
5. Locate two fiber-optic cables that are of equal length.
6. Connect one of the cables between front-panel **REFERENCE EXTENSION** connectors **A** and **B**.

If you have an Option 001 accessory kit, you can stabilize the cable with the cable tray. Coil the cable around as necessary. If you are using more than one cable, place the mid-connectors in the wide part of the slot. Let the ends of the cable protrude from the tray. Be sure to place the cover on the tray.

7. Connect the second fiber-optic cable to the front-panel **TEST PORT**.
8. Connect your device to the **TEST PORT** cable.

### Check setup

9. Press **CHECK SETUP**, and wait for one full measurement sweep to complete.

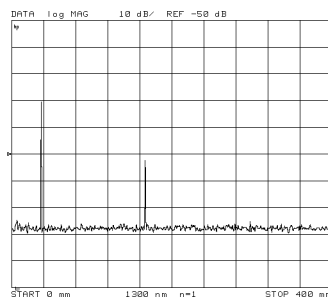

## Running Guided Setups and Calibrations

10. If a response is not visible, perform the following steps:
  - a. Press **CAL**, **CALIBRATE MENU**, and then **BALANCE RECEIVER**.
  - b. Follow the prompts on the screen. Then press **DONE**.
  - c. Wait for one full sweep to complete.
  - d. Press **AVG** and then **AVERAGING ON**.
  - e. Wait for the instrument to average 16 sweeps.  
On the left side of the graticule, the **Avg** number will count to 16.
  - f. Press **SYSTEM** and then **GUIDED SETUP**, and follow the prompts on the screen.
11. Press **CONNECT TERMINATION**.
12. Disconnect the device from the **TEST PORT** cable.

### Connect termination

13. Use the supplied adapter to connect the low reflection termination to the **TEST PORT** cable.



**Low Reflection Termination**

14. Press **BALANCE RECEIVER**.
- ### Balance Receiver
15. Adjust the two polarization balance knobs until the line is in the shaded area.

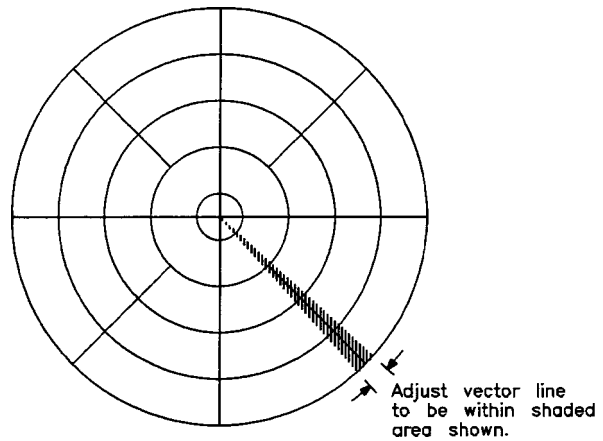

16. Press **DONE**.

**NOTE**

After balancing the receiver, do not move the extension cable or the balance knobs. Movement degrades measurement accuracy.

**Calibrate Magnitude**

17. Disconnect the termination and adapter from the TEST PORT cable.

**Fresnel calibration standard**

The free end of the TEST PORT cable serves as the “Fresnel” calibration standard. When using the supplied cables, the free end of the cable functions as the calibration standard. This is possible because the percentage of light reflected by that type of cable connector is known. (For 1300 nm measurements, the correct value is 3.16%; for 1550 nm, 3.37%.) Other calibration standards (cables, connectors, or devices) may have other reflection values.

18. If you are using the supplied cables, press **FRESNEL**. If you are using another standard, perform the following steps:
- Obtain the standard’s reflection return loss (in dB).
  - Enter this value using the **USER STD** softkey.
19. Press **MEASURE STANDARD**, and *wait* for the standard to be measured.

**Connect Device Under Test**

20. Connect the device to be tested to the TEST PORT cable.
21. Press **MEASURE DEVICE** and then **EXIT SETUP** to complete the guided setup and begin device measurements.

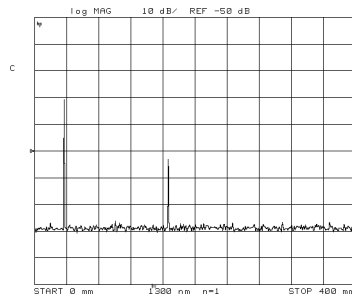



22. As you measure devices, observe the following suggestions:

- Use the **START** and **STOP**, **CENTER** and **SPAN**, and marker keys to optimize the displayed response.

Reducing the span increases measurement speed, improve resolution, and increase dynamic range.

- To improve the signal-to-noise ratio, use averaging. Turn on averaging by pressing **AVG** and then **AVERAGING on OFF** so that **ON** is highlighted.

## To perform a guided calibration

1. Press **PRESET**.
2. Press **1300 nm** or **1550 nm** to select the source wavelength.
3. Press **CAL** and then **GUIDED CAL**.
4. Locate two fiber-optic cables that are of equal length.
5. Connect one of the cables between front-panel **REFERENCE EXTENSION** connectors **A** and **B**.
6. If you plan to measure a device that has a pigtail, continue at step 13 in “To perform a guided setup (devices with pigtail)” in this chapter.
7. If you plan to measure a device that does not have a pigtail, do the following steps:
  - a. Connect the second fiber-optic cable to the front-panel **TEST PORT**.
  - b. Continue at step 13 in “To perform a guided setup (devices without pigtail)” in this chapter.



---

# Performing Manual Calibrations

The precision reflectometer allows you to control many of the aspects of calibrations. For example, you can change the reflection percentage (return loss) used during magnitude calibrations for the standard. You can also prevent the application of calibration data to the measured data.

A full calibration consists of two procedures:

- Balance internal receiver.
- Magnitude calibration.

Both of these procedures are included in guided setups and guided calibrations. This section shows you how to run these procedures separately.

## Calibrating pigtailed devices

As shown in the *guided setup* procedure, there are slight differences between the steps used to calibrated devices with or without pigtails. If the device has a pigtail, during the balance receiver calibration the low-reflection termination is connected directly to the **TEST PORT** connector instead of at the end of a cable. During the magnitude calibration, a fiber-optic cable that is the same length as the pigtail is connected to the **TEST PORT** connector.

## Calibration standards are provided

A magnitude calibration consists of measuring a “standard” of known reflection at the end of the **TEST PORT** cable. The instrument then scales the measured response to match the amplitude of the “standard” so that the true value is displayed.

The fiber-optic cables supplied with the precision reflectometer can be used as calibration standards. This is because the cable’s open end is a very accurate and repeatable calibration standard. (The insertion loss at the front panel connection is not taken into account.)

The return loss of the fiber end of these cables is known to have the following values:

1300 nm .....	15 dB (3.16% reflection)
1550 nm .....	14.7 dB (3.37% reflection)

The values listed above are derived from the following formulas:

$$-15 \text{ dB} = 10 \text{ Log } 0.0316$$

$$-14.7 \text{ dB} = 10 \text{ Log } 0.0337$$

You can direct the precision reflectometer to use your own calibration-standard values during a magnitude calibration. Using your own optical device of known reflectance for a standard can improve dynamic accuracy.

### **Ensuring accuracy of low-level reflections**

When observing reflections at low levels, perform the balance receiver calibration periodically after a full calibration to ensure better accuracy. Periodically balancing the receiver helps to remove small “drifts” when displaying very small signals. This drifting occurs most often when the instrument is not allowed to temperature stabilize for at least one hour prior to use.

#### **Polarization balance calibration: the inside story**

The receiver contains a polarization splitter that splits any incoming light into two orthogonal polarizations. (Refer to “Block Diagram” in Chapter 5 for a block diagram of the instrument.) A photodiode mixes the optical fields reflected from the two arms of the interferometer and generates the interference signal in each polarization. To ensure proper operation of the receiver, the reference arm reflections needs to be about equally split between the two polarizations. The balance receiver calibration ensures that this condition is met.

During balance receiver calibration, the **TEST PORT** cable is terminated with a low reflection termination. This means substantially that the only light that hits both receiver detector diodes is from the mirror in the reference light path. The polarization of this light is then adjusted by the front panel reference polarization balance knobs such that the responses from each detector are equal, or balanced. Subsequent measurements of polarization-independent return loss are then insensitive to polarization transformations of the fiber in the test arm.

## Performing Manual Calibrations

### Reduce the effects of chromatic dispersion at 1550 nm

You can turn off the use of chromatic dispersion correction data. This allows you to use your own correction methods.

When making measurements at 1550 nm, the amount of chromatic dispersion experienced by the light traveling in the reference path will be less than that in the path of the device being tested. This is due to that fact that, in most cases, light traveling in the path with the device being tested is all in fiber. However, part of the reference path is in an open beam (inside the HP 8504B). This mismatch in dispersion results in a broadening and subsequent drop in the peak value of the displayed reflection “impulse”.

The peak value decreases monotonically as a function of the length of the dispersion mismatch. This effect is consistent and has been corrected out by the precision reflectometer. The instrument assumes a dispersion coefficient of 17 ps/(nm)(km). The result of this correction leaves a residual error on the order of  $\pm 0.3$  dB. If the path to the device being tested is both in fiber and an open beam, the effects are very difficult to remove from the measurement; subsequent uncertainties due to chromatic dispersion can approach 5 dB.

### External sources can be used

In addition to the internal 1300 nm and 1550 nm sources, you can use an external source for measurements. (The external source input is provided as a convenience for users with very advanced applications. It is not meant for the typical user.) The external source must be able to be modulated with a 27 kHz signal. When using an external source, normal calibration and correction features are not applied to the measurement data. Refer to “To calibrate for an external source” to learn how to calibrate the precision reflectometer for use with an external source.

---

## To balance the receiver

1. Turn the precision reflectometer on, and allow it to warm up for at least one hour.
2. Locate two fiber-optic cables that are of equal length.  
If you plan to measure a device that has a pigtail, the cables must be equal to (or up to 240 mm shorter than) the length of the pigtail.
3. Connect one of the cables between front-panel **REFERENCE EXTENSION** connectors **A** and **B**.
4. If you plan to measure a device that does not have a pigtail, connect a low-reflection termination to **TEST PORT** using the remaining fiber-optic cable.
5. If you plan to measure a device that has a pigtail, connect a low-reflection termination directly to the **TEST PORT**.

### **NOTE**

Do not move the reference extension cable for the rest of this procedure. Any movement of this cable will change the reference signal polarization and will invalidate the calibration.

6. Press **CAL** and then **CALIBRATE MENU**.
7. Press **BALANCE RECEIVER**.
8. Adjust the two polarization balance knobs until the line is in the shaded area.

**Performing Manual Calibrations**

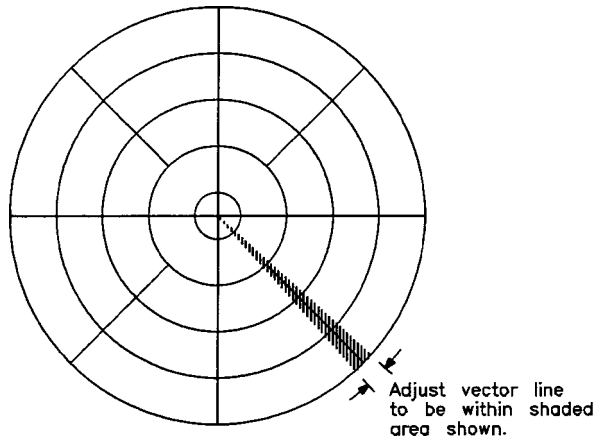

9. Press **DONE**.

10. Remove the low-reflection termination.



---

## To calibrate the magnitude

Always balance the receiver before calibrating the magnitude. Balancing the receiver ensures that the displayed response magnitude is insensitive to the polarization transformations of the fiber in the test arm when the return loss of the device being tested is polarization-independent.

1. Calibrate the reference balance as described in “To balance the receiver”.
2. If you plan to measure a device that has a pigtail, connect a fiber-optic cable to the **TEST PORT**.

This cable must be equal to the length of the cable that is attached to the **REFERENCE EXTENSION** connectors.

3. Press **CAL** and then **CALIBRATE MENU**.
4. Press **CALIBRATE MAGNITUDE**.
5. Select a standard:
  - Press **FRESNEL** to select the standard default value.
  - Press **USER STD** to use your own standard. Enter the reflection return loss (in dB) of your standard.

The sweep can be at any position. The Fresnel value listed is the percentage of reflectance of the open end of the fiber-optic cable.

6. Wait until the asterisk on the display's left-hand side disappears and the letter **C** remains below the asterisk.

You should see a Fresnel response on the display due to a reflection from the end of the **TEST PORT** cable.

## To calibrate for an external source

1. On the lightwave section's rear panel, locate the cover plate that is just left of the **I.O. INTERCONNECT** cable.
2. Turn the two thumbscrews to remove the cover plate.
3. Disconnect the green fiber-optic cable, and put a protective cap on it.
4. Turn the external source off.
5. Connect a fiber-optic cable from your external source to the **SOURCE ARM INPUT** connector.
6. Turn the precision reflectometer on, and allow it to warm up for at least one hour.
7. Locate two fiber-optic cables that are of equal length.

If you plan to measure a device that has a pigtail, the cables must be equal to (or up to 240 mm shorter than) the length of the pigtail.

8. Connect one of the cables between front-panel **REFERENCE EXTENSION** connectors **A** and **B**.
9. If you plan to measure a device that does not have a pigtail, connect a low-reflection termination to **TEST PORT** using the remaining fiber-optic cable.
10. If you plan to measure a device that has a pigtail, connect a low-reflection termination directly to the **TEST PORT**.

### **NOTE**

Do not move the reference extension cable for the rest of this procedure. Any movement of this cable will change the reference signal polarization and will invalidate the calibration.

11. Press **(MENU)** and then **EXTERNAL**.

12. Press **CAL** and then **CALIBRATE MENU**.

13. Press **BALANCE RECEIVER**.

---

**CAUTION**

---

The power of the external source should not exceed 5 mW. Power levels greater than 5 mW can damage the HP 8504B.

14. Turn the external source on. Intensity modulate the external source at 27 kHz.

Without the modulation, the displayed response contains a high noise level.

15. Adjust the two polarization balance knobs until the line is in the shaded area.

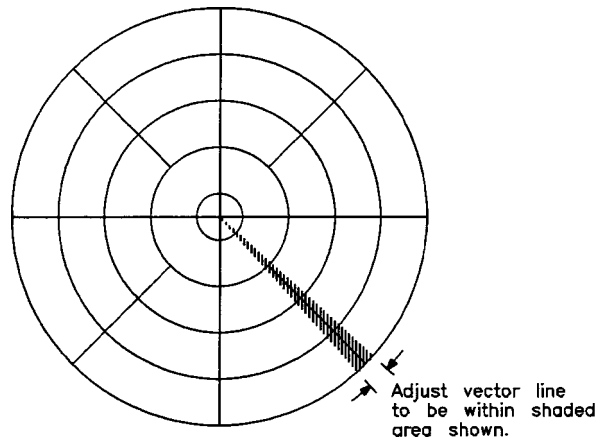

16. Press **DONE**.

17. Remove the low-reflection termination.

18. Continue with step 2 of "To calibrate the magnitude" in this section.

## Performing Manual Calibrations

---

### To turn off calibration data

This procedure does not destroy the calibration data. It only prevents its application to the measurement data. Turning the calibration on, restores the previous calibration.

1. Press **CAL**.
  2. Press **CORRECTION** on **OFF** so that **OFF** is selected.
- 

### To enter the standard's reflection percentage

1. Press **CAL**.
  2. Press **CALIBRATE MENU**.
  3. Press **USER STD**, and enter the reflection return loss (in dB) to be used during magnitude calibrations for your standard.
  4. To return to the default value, press **FRESNEL**.
- 

### To turn chromatic dispersion correction on and off

1. Press **CAL**.
  2. Press **CALIBRATE MENU**.
  3. Press **DISPER COR** on **OFF** so that **OFF** is selected.
-

---

## To use the Option 001 cable tray

The maximum length of cable that can be coiled inside the tray is approximately 200 cm (79 inches).

1. Connect one end of the fiber-optic cable to the front panel **REFERENCE EXTENSION B** connector.
2. Coil the cable in the tray as shown in the following figure. Do not allow any more cable outside the cable tray than is necessary.

If the cable must be lengthened inside the tray by using two cables and an adapter, put the connectors and adapter in the foam cutout inside the cable tray.

3. Connect the remaining end of the fiber-optic cable to the front-panel **REFERENCE EXTENSION A** connector.

---

**CAUTION**

Fiber optic cable can be irreparably damaged by bending it into circles with diameters less than 50 mm (2 inches). This damage is mainly caused by stretching the cable.

4. Attach the top onto the main body of the cable tray.

Performing Guided Setups and Calibrations  
**Performing Manual Calibrations**

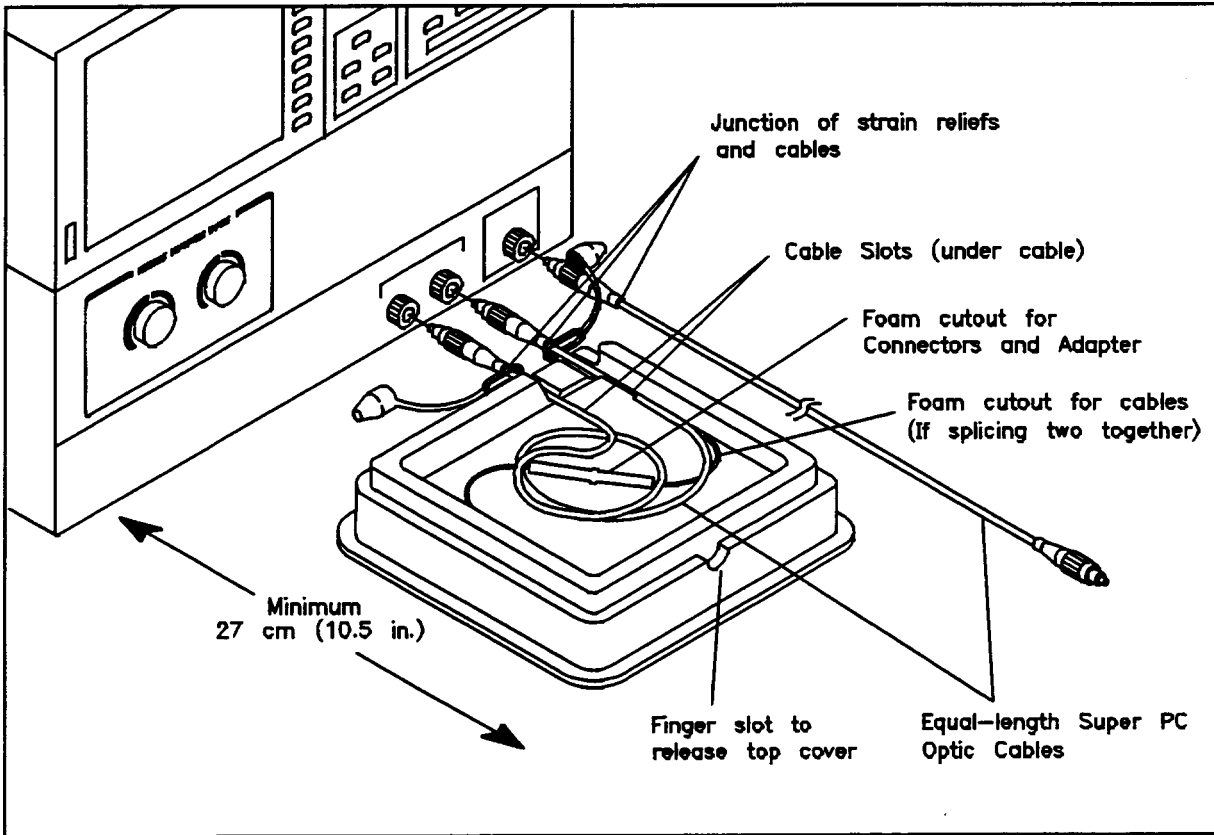

---

## Performing Measurements

---

# Performing Measurements

Once you've calibrated the precision reflectometer, you're ready to make measurements. In this chapter, you'll learn about changing the measurement range, temporarily storing traces, and changing the colors on the display. You'll also learn how to use displayed markers and how to test the shape of displayed responses using limit lines. Limit lines are valuable tools for pass/fail testing on production lines.

The last section of this chapter shows you how to create hard copies of the display on a printer or plotter. In addition to getting hardcopies of the screen, the precision reflectometer can print or plot a listing of all measurement points and instrument parameters.

## Contents

Setting the Measurement Range .....	3-4
To select the source wavelength .....	3-6
To automatically tune to a response .....	3-7
To change the displayed scale .....	3-7
To change the refractive index .....	3-8
Reducing Displayed Noise .....	3-9
To reduce the displayed noise .....	3-11
Using Markers .....	3-12
To display a peak response .....	3-16
To change the measurement range .....	3-16
To make relative measurements .....	3-16
To position a fixed reference marker .....	3-17
To change the peak definition .....	3-17
To turn markers off .....	3-18
Creating Limit Lines .....	3-19
To enter limit-line segments .....	3-23
To display or hide limit lines .....	3-23
To turn on limit testing .....	3-24
Tutorial: Using Limit Lines .....	3-25
Storing Traces to Memory .....	3-34
To view memory traces .....	3-35



**Contents (continued)**

Saving Instrument States to Registers .....	3-36
To save to a register .....	3-38
To recall a register .....	3-38
To increase user memory .....	3-39
Saving Instrument States to Files .....	3-40
To save to a disk .....	3-41
To change a file name .....	3-42
To recall an external file .....	3-43
To delete an external file .....	3-43
To format an external disk .....	3-43
To connect a disk drive .....	3-44
Changing Colors and Audible Warnings .....	3-45
To adjust displayed colors .....	3-45
To turn on the warning beep .....	3-45
To turn off the “done” beep .....	3-46
Printing and Plotting .....	3-47
To print the display .....	3-48
To plot the display .....	3-48
To print or plot measurement and parameter values .....	3-49
To enter the printer/plotter type and address .....	3-49
To abort a print or plot .....	3-50

---

# Setting the Measurement Range

It's easy to set the precision reflectometer's measurement span. Simply select the appropriate setting using the **(START)** and **(STOP)** keys or **(CENTER)** and **(SPAN)** keys. Then, use the front-panel knob, step keys, or numeric key pad to enter the value. Annotation that is displayed on the screen shows measurement settings such as source wavelength, vertical and horizontal scales, reference level, and refractive index.

You can zoom to responses swiftly using automated search and scale functions. As you use the instrument, notice that reducing the span makes sweep speed faster and increases the measurement sensitivity.

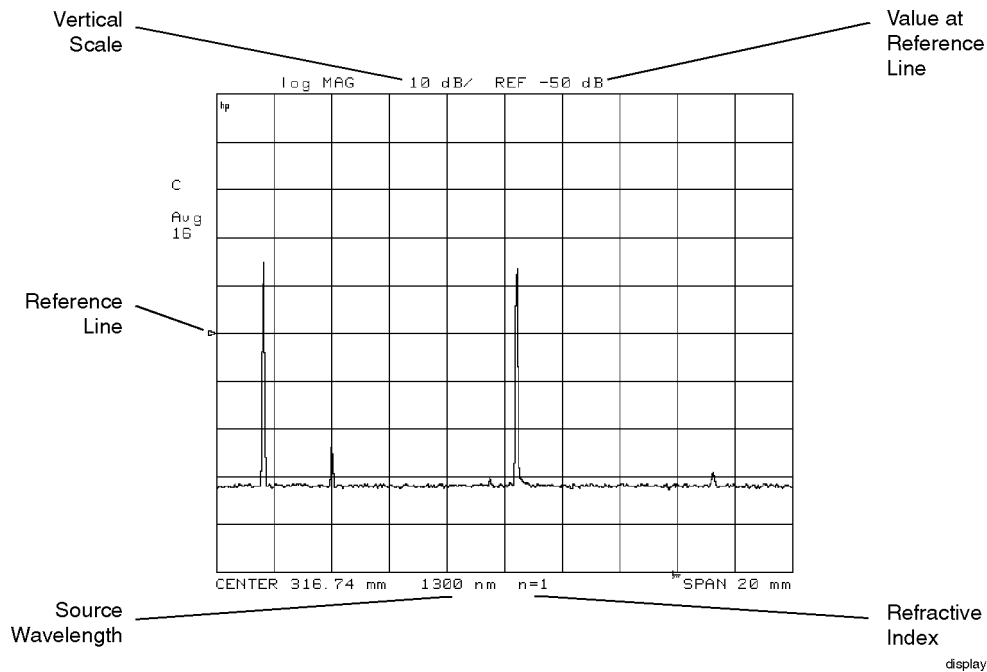

**Horizontal scale readings depend upon refractive index**

The precision reflectometer's maximum measurement span depends upon the refractive index of the light path. The default horizontal scale corresponds to a refractive index ( $n$ ) of 1. (This is the value for light in air; and it gives the precision reflectometer's maximum range of 400 mm.) Entering a different refractive index, using the **REFRACTIVE INDEX (n)** softkey, changes the horizontal scale *but* not the position of responses on the display.

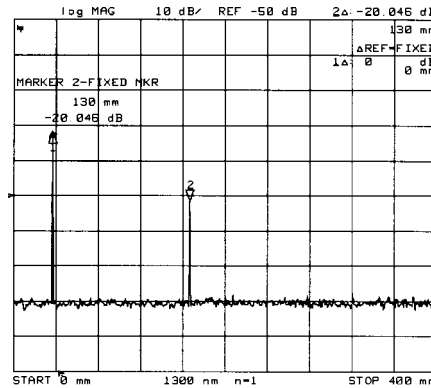

**Refraction index = 1.**

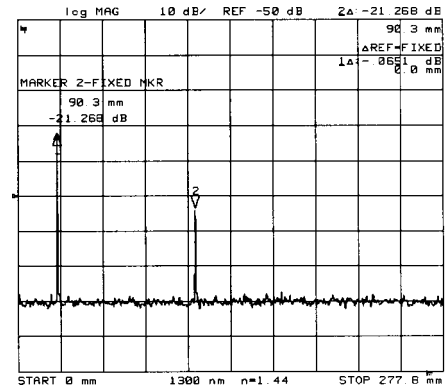

**Refraction index = 1.44.**

The precision reflectometer is designed so that if the lengths of the **REFERENCE EXTENSION** and **TEST PORT** cables are equal, the first response appears approximately one division to the right of the display's left edge in a 400 mm span. (This response is reflected from the end of the **TEST PORT** cable.) For every 28 millimeters that the **TEST PORT** cable is longer than the **REFERENCE EXTENSION** cable, this response moves one division towards the right. Twenty-eight millimeters of actual fiber length has an equivalent air length of 40 mm.

**Return to full span with the press of a key**

You can return the instrument to the full 400 mm span at any time by pressing **(MENU) FULL SPAN**. Next to the **FULL SPAN** key, you'll find the **ZERO SPAN ON OFF** softkey. This softkey make the precision reflectometer into what is essentially a programmable delay line. It sets the center setting to the former start value and stops the sweep (mirror movement).

**Setting the Measurement Range****The sweep can be stopped**

Normally, the precision reflectometer sweeps the measurement range continually. Single sweeps are available by pressing **(MEAS) SINGLE**. Each time this softkey is pressed, one sweep is taken and then the sweep stops.

You also can force any sweep to restart at the beginning regardless of the current sweep position. This is especially valuable in wide measurement spans where sweeps take a few seconds to complete. To restart a sweep, press **(MEAS) MEASURE RESTART**.

**External sources can be used**

In addition to the internal 1300 nm and 1550 nm sources, you can connect an external source for the measurements. The external source input is provided as a convenience for users with very advanced applications. It is not meant for the typical user. When using an external source, normal calibration and correction features are not applied to the measurement data. Refer to “To calibrate for an external source” in Chapter 2 to learn how to calibrate the precision reflectometer for use with an external source.

---

## To select the source wavelength

1. Press **(MENU)**.
2. Press **1300 nm** or **1550 nm** to select the wavelength.

The **EXTERNAL** selection turns off the internal sources. The external source input is provided as a convenience for users with very advanced applications. Note that normal calibration and correction features are not available with an external source. Use the entry keys to enter the wavelength of the external source.

---

## To automatically tune to a response

1. Press **(MKR FCTN)**.
2. Press **MAX SEARCH**.
3. If the marker is not on the desired response, use the front-panel knob to place the marker on the response.
4. Press **MKR ZOOM** as needed to center the response and reduce the measurement span.
5. Press **(SCALE REF)** and then **AUTO SCALE**.

---

## To change the displayed scale

1. Press **(FORMAT)**.
2. Select the horizontal measurement units:
  - **DISTANCE**
  - **TIME**
3. Select the vertical scale:
  - **VERT: LOG MAG** selects a logarithmic scale.
  - **LIN MAG** selects a linear scale.
4. Press **(SCALE REF)**.
5. Press **REFERENCE VALUE**, and enter the value at the reference position line.

The reference position line's default position is at the center of the screen.
6. Press **SCALE (/DIV)**, and enter the desired units per vertical division.

## To change the refractive index

1. Press **(MEAS)**.
2. Press **REFRACTIVE INDEX (n)** and enter a refractive index value from 1 to 200.

The default value is 1.

---

# Reducing Displayed Noise

The precision reflectometer can average the data from several traces. Averaging reduces displayed noise especially when used with narrow spans. For best accuracy, use averaging on the minimum span:

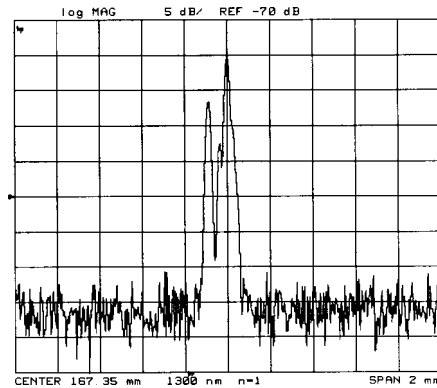

**Averaging off.**

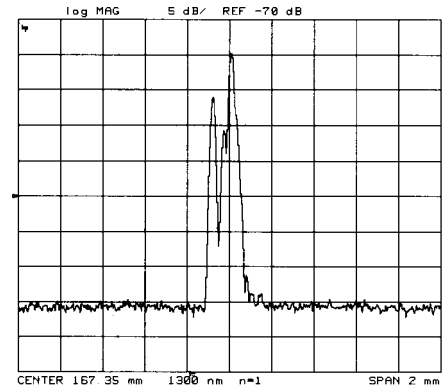

**Averaging on.**

The default number of trace averages is 16.

Source	Minimum Span (n = 1)
1300 nm	1 mm
1550 nm	1.2 mm

In wide spans, the precision reflectometer captures more data points than it can display; adjacent data points are grouped and then the maximum point for each group is displayed. As the span is decreased, the number of points per group decreases until all the points are displayed.

Since, in wide spans, the maximum value is averaged, there is a difference between the averaged value and the true value of a signal. The difference (or inaccuracy) increases with noise or span.

**Reducing Displayed Noise**

The following equation shows the algorithm:

$$A_n = \frac{S_n}{K_n + \left(1 - \frac{1}{K_n}\right) (A_{n-1})}$$

where:

$A_n$  = current average

$S_n$  = current measurement

$K_n$  =  $n$  for  $n < F$  or  $F$  for  $n \geq F$

$F$  = averaging factor



---

## To reduce the displayed noise

1. Press **AVG**.
2. Press **AVERAGING FACTOR**, and enter the number of traces you want to average.
3. Press **AVERAGING on OFF** so that **ON** is highlighted.
4. You can restart averaging at any time by pressing **AVERAGING RESTART**.

# Using Markers

Markers allow you to read the amplitude values at any position on the trace. You can easily determine the distance and amplitude value of any response. The active marker is shown on the display as a  $\nabla$  symbol. Inactive markers are shown with the  $\Delta$  symbol. The following figure shows markers 1 through 4. Marker 3 is active; markers 1, 2, and 4 are inactive. Notice that marker 4 is a delta marker. Delta markers measure the difference between two positions on the display.

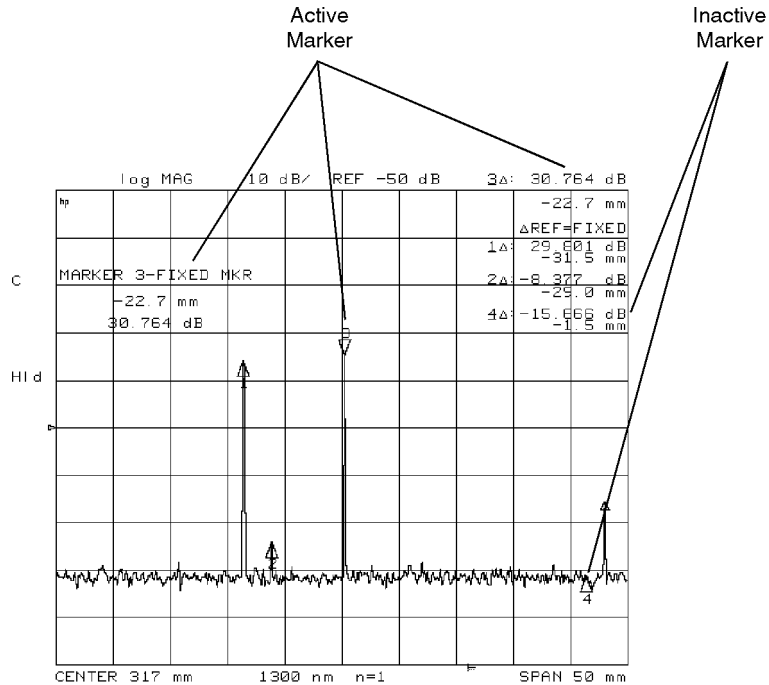

markers

Markers are accessed from two front-panel keys:

- Use **MRK** to display up to four markers, an additional fixed marker, and delta markers.
- Use **MKR FCTN** to search for peak responses and to change the measurement span based on marker positions.

The active marker can be moved to any point on the trace. When a logarithmic amplitude scale is used, response values are displayed in dB; when a linear amplitude scale is used, values are shown as the ratio of reflected power to the incident power. The displayed marker values are valid even when the measured data is above or below the range displayed on the screen.

**Δ markers display relative values**

When displaying delta markers, any of the four markers or a fixed point can be designated as the reference marker. The displayed markers show the relative distance (or time) and amplitude from this reference marker. The delta reference is displayed as a small Δ character. (This character is smaller than the inactive marker triangles.) If one of the markers is the reference, the delta character appears next to the marker number on the trace.

**The fixed marker is a special delta marker reference**

Each of the four standard markers can only be positioned on the trace. However, the fixed marker can be positioned anywhere on the screen; it is not limited to the trace. Use **FIXED MKR POSITION** and **FIXED MKR VALUE** to position the fixed marker. The fixed marker can be set to the current active marker position, by pressing **MARKER → FIXED MARKER**. Other markers can then be activated and their values referenced to the fixed marker.

**What if a memory trace is displayed?**

If both data and memory are displayed, the marker values apply to the data trace. If memory only is displayed, the marker values apply to the memory trace.

**You can define a peak**

You can change the amplitude variation required for a peak to be identified. The default value is 6 dB. The value specifies the amount that a trace must increase and then decrease, relative to the surrounding responses or noise floors, in order to be defined as a peak.

If peak excursion is defined as 20 dB, then the values of **a** and **b**, shown in the following figure, must be at least 20 dB in order to be considered a

**Using Markers**

peak. Values **a** and **b** represent the respective amplitudes of both sides of a maximum response. The allowable excursion values range from 0 to 100 dB.

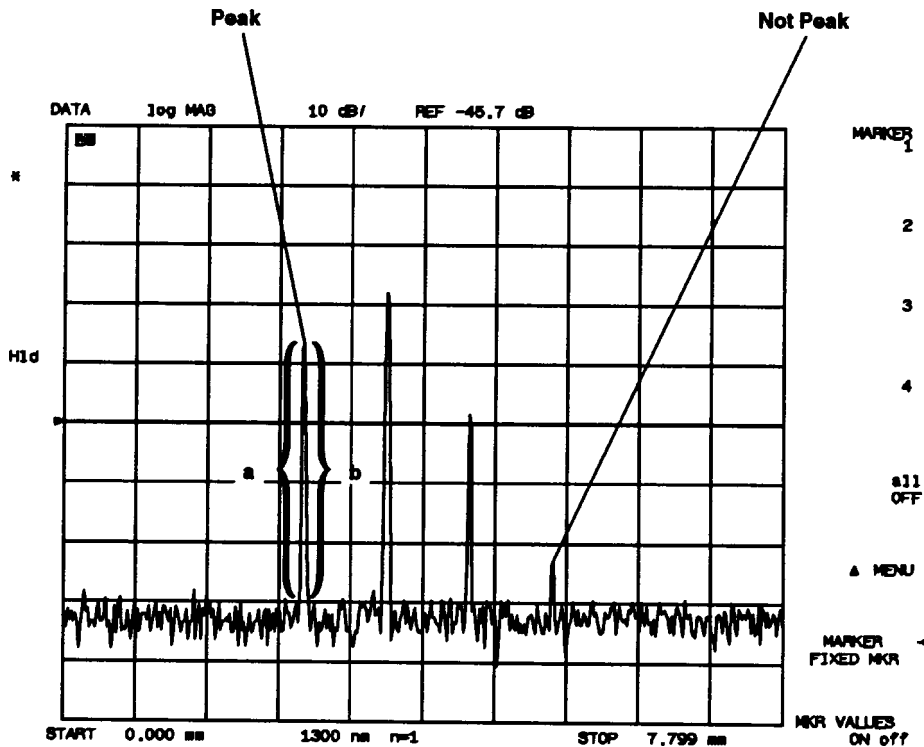

You can also set the level below which nothing will be considered a peak. This is the peak threshold value. The maximum amplitude of the response must be at least this value to be called a peak. The allowable threshold values range from  $-100$  to  $0$  dB. The default value is  $-75$  dB.

Any part of a peak (as defined by peak excursion) that is less than the peak threshold value is also used to satisfy the peak excursion criteria. For example, when the peak excursion is set to 8 dB, a peak that is 4 dB above and 4 dB below the peak threshold will be considered a peak.

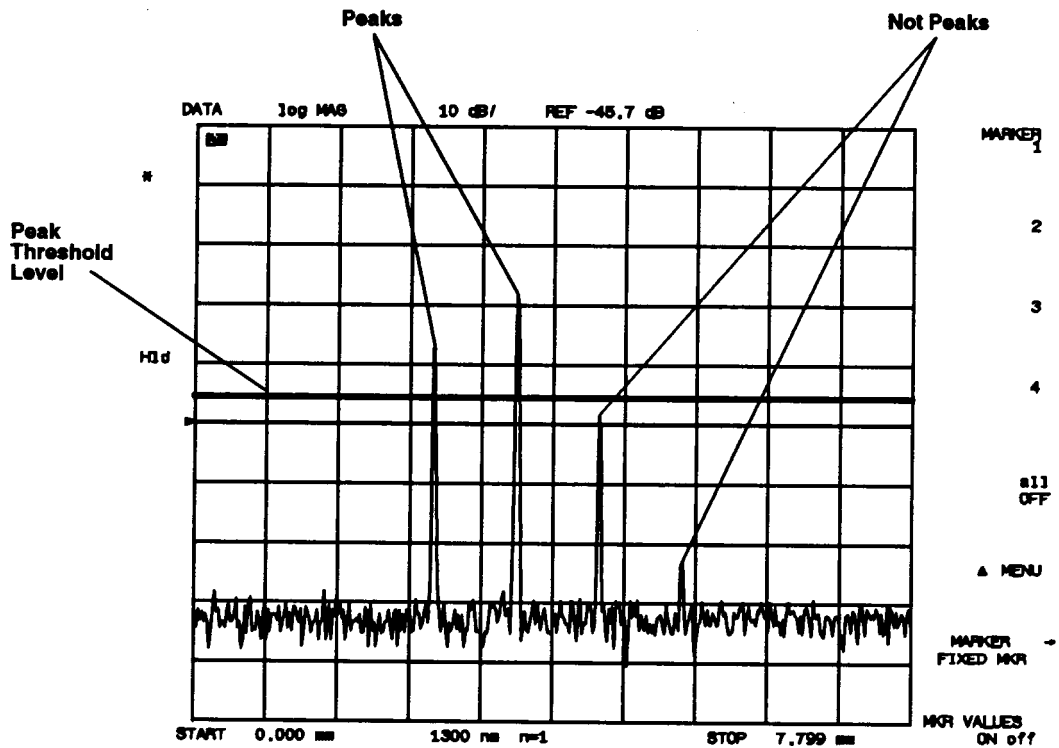

## To display a peak response

1. Press **(MKR FCTN)**.
  2. Press **MAX SEARCH**.
  3. If the marker is not on the desired response, front-panel knob or **PEAK SEARCH** menus to place the marker.
  4. Press **MKR ZOOM** as needed to center the response and reduce the measurement span.
- 

## To change the measurement range

1. Press **(MKR FCTN)**.
  2. Use the front-panel knob to position the marker at the desired start position. Press **MARKER Δ START**.
  3. Use the front-panel knob to position the marker at the desired stop position. Press **MARKER Δ STOP**.
- 

## To make relative measurements

1. Press **(MKR)** and then **MARKER 1**.
  2. Position marker 1 at the reference position from which relative measurements will be made.
  3. Press **Δ MENU**.
  4. Press **ΔREF=MKR 1** and then .
-

5. Press **MARKER 2** to read delta values (marker 2 – marker 1).

---

## To position a fixed reference marker

1. Press **(MKR)** and then **Δ MENU**.
2. Press **ΔREF= FIXED MKR**.
3. Press **FIXED MKR MENU**.
4. Position the marker using **FIXED MKR POSITION** and **FIXED MKR VALUE**.

You can also specify the position value using the **(MKR)**  
**MARKER → FIXED MKR** or **(MKR FCTN) MARKER → FIXED MKR**  
softkeys.

---

## To change the peak definition

1. Press **(MKR FCTN)** and then **PEAK SEARCH**.
2. Press **DEFINE PEAK** and then **PEAK EXCURSION**.
3. Enter the value that defines a peak.
4. Press **PEAK THRESHOLD** and enter the value below which nothing will be considered a peak.

---

## To turn markers off

1. Press **MKR**.
2. Press **all OFF**.



---

# Creating Limit Lines

Limit lines allow you to test the shape of displayed responses. Limit testing compares the measured data with the defined limits, and provides pass or fail information for each measured data point. Because limit lines allow you to perform repetitive testing of response shapes, they are ideal for pass/fail testing on production lines. The tutorial at the end of this section provides an excellent method of learning about limit lines. It takes only a few minutes to complete.

Press **SYSTEM** and then **LIMIT MENU** to access limit-line functions. Limit lines consist of segments which are entered in tabular form in limit-line tables. Each segment has an upper and lower limit. The lower limits in the following figure are at  $-200$  dB and so are off the displayed scale.

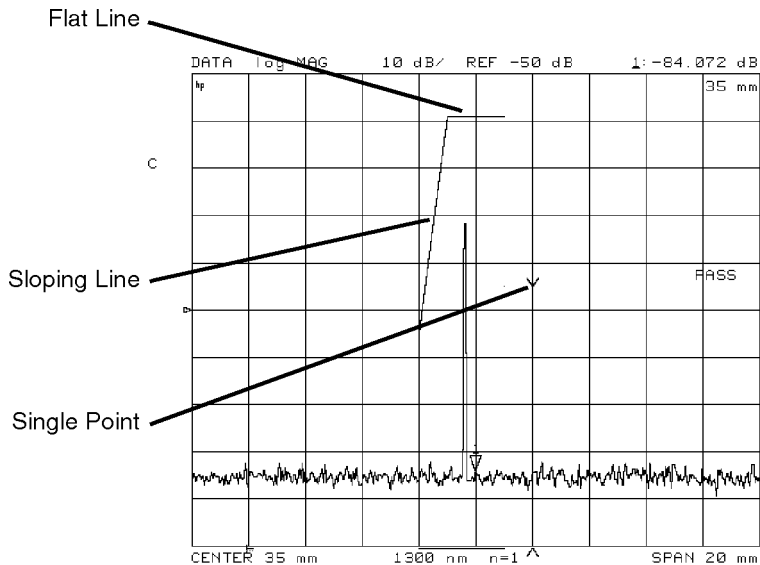

tutor1

**Creating Limit Lines**

If limit lines are turned on:

- They are displayed.
- They are included on plots and prints.
- In tabular format, upper limit, lower limit, and pass/fail margins are listed (space permitting).
- Limit lines are saved in instrument states.

If limit testing is turned on:

- PASS or FAIL is displayed (even if the limit lines are not displayed).
- Failing portions of the trace are displayed in a different color.

**Entering limit lines is easy**

For each segment, you must enter a starting position (distance or time), an upper and lower limit, and the segment type. Alternately, you can enter delta limits instead of upper and lower limits. For example, a device may be specified at 0 dB  $\pm$ 3 dB. Enter the middle value as 0 dB and the delta limits as 3 dB.

You can enter these values using the key pad or by setting the marker at the value and pressing **MARKER**  $\rightarrow$  **POSITION** or **MARKER**  $\rightarrow$  **MIDDLE**.

Up to 22 limit-line segments can be added to the table in any order. The precision reflectometer automatically sorts them. The table shows up to three segments; to scroll through a longer table, use the **SEGMENT** softkey. In the table, a pointer character > shows which segment is selected for editing. If you need edit a segment, select it first using the **SEGMENT** softkey.

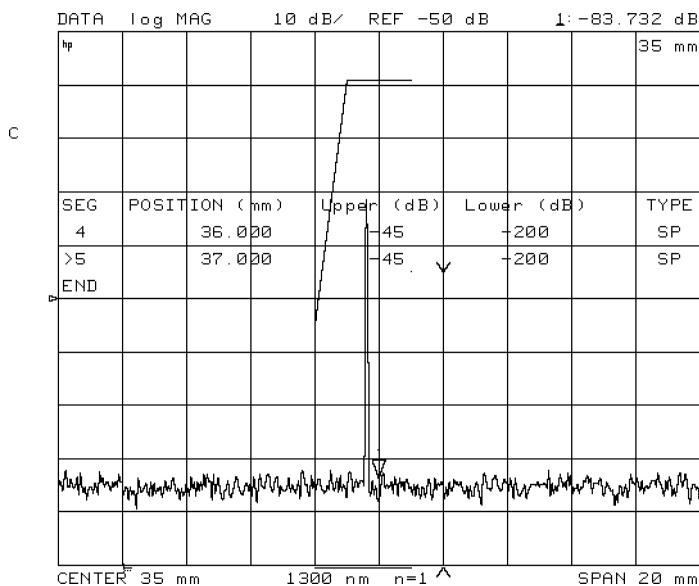

**The limit-line table.**

**There are three segment types**

There are three types of segments: sloping line, flat line, and single point. Limit line tables can hold up to 22 segments.

Sloping Lines (SL) are drawn as ramps from the previous segment to the next segment (line or point). Unless terminated by another segment, they continue to the far right of the screen.

Flat Lines (FL) are drawn as steps from the horizontal position (but not vertical location) of the previous segment. Unless terminated by another segment, they continue to the far right of the screen.

Single Points (SP) are drawn as carets (Λ or V) at the indicated position when stand-alone. When used to terminate a line segment, the caret is not drawn.

**Creating Limit Lines****Indications of pass/fail conditions**

Several indications of pass or fail status are provided when limit testing is on:

A **PASS** or **FAIL** message is displayed at the right of the display.

- The trace vector leading to any measured point that is out of limits is displayed in a different color. It appears normal on a print or plot.
- The limit fail beeper sounds if it is turned on.
- An asterisk \* is shown next to any listed point that is out of limits.
- A bit is set in the HP-IB status byte.

**NOTE**

Limits are checked only at the actual measured data points. If the point density is insufficient, a device can be out of specification without displaying **FAIL**. Be sure to specify a suitable number of measurement points.

**Limit lines can be shifted**

Limit lines can be offset horizontally or vertically. This is useful for changing the limits to correspond with a change in the test setup, or for device specifications that differ in stimulus or amplitude. It can also be used to move the limit lines away from the data trace temporarily for visual examination of trace detail.

**NOTE**

The three offset keys (**AMPLITUDE OFFSET**, **MARKER → AMP.OFF.**, and **POSITION OFFSET**) shift the limit segments but do not change the limit values in the table. If the limit segments look out of place, check to see if they have been shifted in position or amplitude.

---

## To enter limit-line segments

1. Press **(SYSTEM)**.
2. Press **LIMIT MENU**, and then **LIMIT LINE on OFF** so that **ON** is highlighted.
3. Press **EDIT LIMIT LINE**.
4. For each segment that you want to add, do the following:
  - a. Press **ADD**, and enter the limit-line values:
    - **POSITION VALUE** and **MARKER → POSITION** enter the starting position or time.
    - **UPPER LIMIT** and **LOWER LIMIT** enters absolute amplitude limits.
    - **DELTA LIMITS** and **MIDDLE VALUE** enters limits equally spaced around a middle value.
  - b. Press **DONE**.
  - c. Use the **LIMIT TYPE** softkey to enter the segment **TYPE**: flat, slope, or single point.

---

## To display or hide limit lines

1. Press **(SYSTEM)**.
2. Press **LIMIT MENU**, and then **LIMIT LINE on OFF**.

## To turn on limit testing

1. Press **SYSTEM**.
2. Press **LIMIT MENU**, and then **LIMIT TEST on OFF**.

The words **PASS** or **FAIL** should appear on the screen.

3. Press **BEEP FAIL on OFF** so that **ON** is highlighted if you want the instrument to sound an alarm when a limit-line is crossed.

## Tutorial: Using Limit Lines

The following example procedure draws the limit lines shown below.

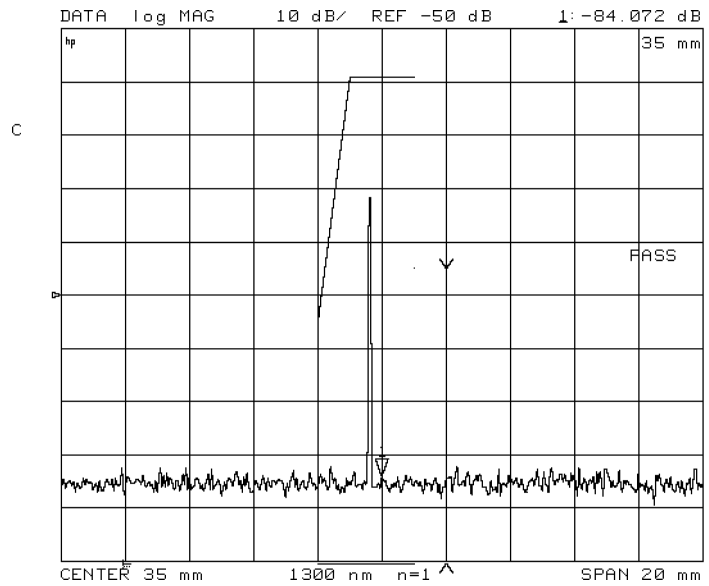

**Limit Line Table**

SEG	POSITION (nm)	Upper (dB)	Lower (dB)	TYPE
1	33.000	-55	-200	SL
2	34.000	-9	-200	FL
3	36.000	-45	-200	FL
4	36.000	-45	-200	SP
5	37.000	-45	-200	SP

**Creating Limit Lines****View a Fresnel response**

1. Attach one of the 75 cm fiber optic cables to the front-panel **TEST PORT** connector.
2. If there is a protective cap on the free end of the fiber-optic cable, remove it.
3. Attach the other 75 cm cable between the front-panel **REFERENCE EXTENSION** connectors A and B.
4. Press **PRESET**.
5. Press **CAL** and then **GUIDED CAL**.
6. Follow the instructions on the display to calibrate the instrument. You do not need to put a device on the test port cable after completing the calibration.

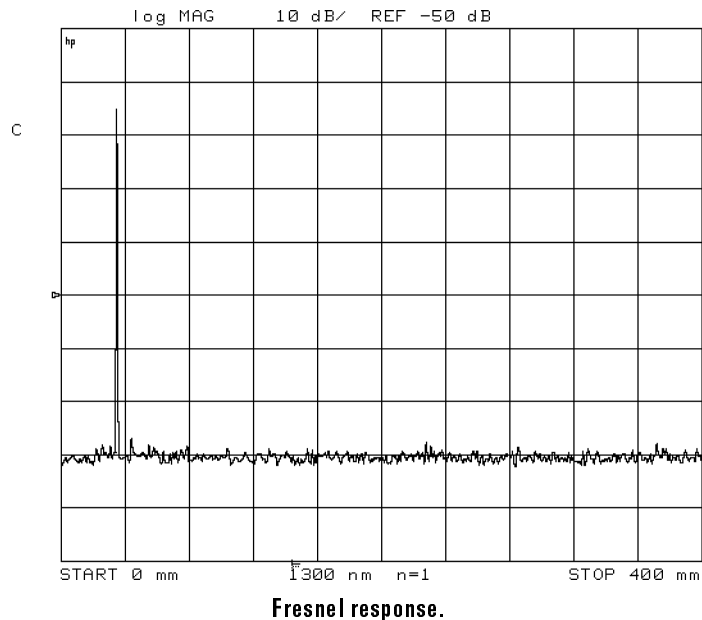

7. Press **MKR FCTN**, **MAX SEARCH**, and then **MKR ZOOM**.

The response should be centered with the measurement span at 20 mm.



**Draw the limit-line segments**

8. Press **SYSTEM**.

9. Press **LIMIT MENU** and then **LIMIT LINE ON**.

This makes the limit lines visible. Don't worry if the position of the signal on your screen doesn't exactly match the figures in this tutorial. At the end of the tutorial, you can simply increase the measurement span and move the limit lines.

10. Press **EDIT LIMIT LINE**.

11. Press **ADD** to enter a limit segment and turn on a marker.

The reflectometer enters a default segment for you. This segment is positioned horizontally at 400 mm, has upper and lower vertical limits of 0 dB, and is a sloping line (SL). It is not visible now.

12. Press **POSITION VALUE**, and enter 33 mm.

A limit line appears on the screen at the 0 dB level (the top graticule line in this example).

13. Press **UPPER LIMIT**, and enter -57 dB.

Press **x1** to terminate the entry. This moves the limit line down to -57 dB. What looks like one line is actually two: limit lines are entered in pairs.

14. Enter -55 dB to move the upper limit line up to -55 dB. See the following figure.

**Creating Limit Lines**

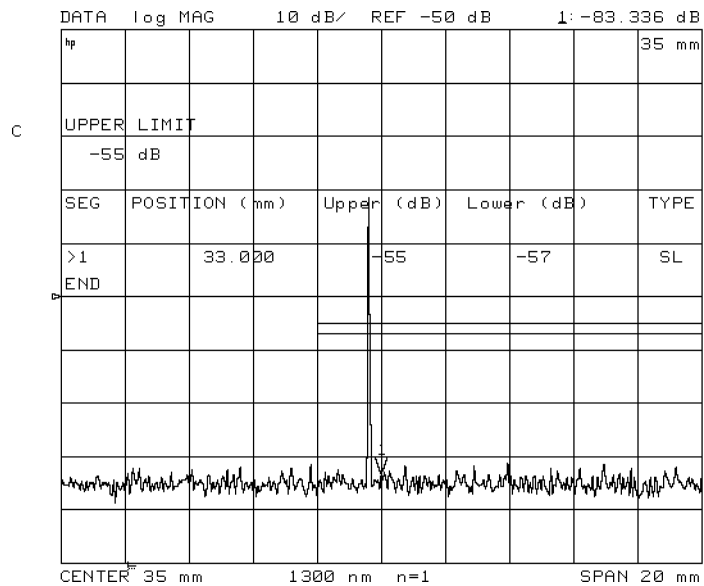

15. Press **LOWER LIMIT**, and enter a value of  $-200$  dB.

This forces the lower limit to a low value.

16. Press **DONE** to finish editing the first limit segment.

17. Press **ADD** and then **POSITION VALUE** and enter a value of 34 mm.

18. Press **UPPER LIMIT** and enter a value of  $-9$  dB.

Press **DONE**.

This ends the first segment at 34 mm,  $-9$  dB and starts the second segment at the same place.

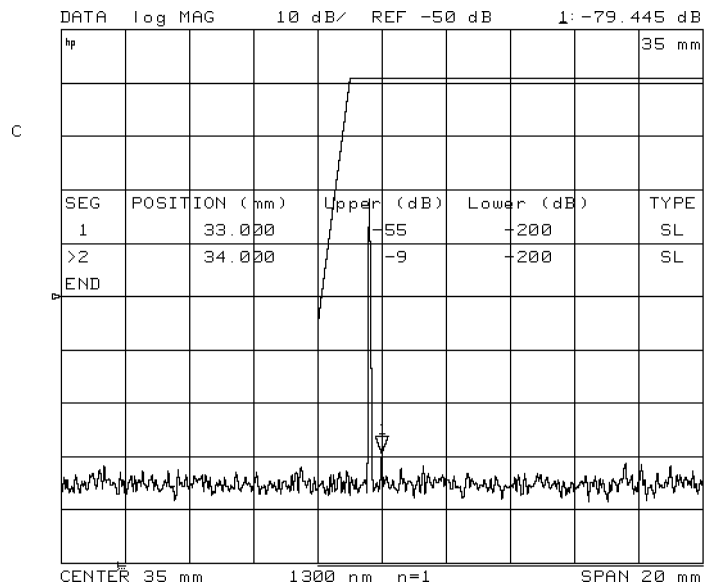

19. Press **LIMIT TYPE**, **FLAT LINE**, and then **RETURN**.

This defines the second segment as a flat line. Note that “Type” is now “FL.”

20. Press **ADD**, **POSITION VALUE**, and enter a value of 36 dB.
21. Press **UPPER LIMIT**, and enter a value of -45 dB.
22. Press **DONE**.

Note that flat lines begin and end at the same horizontal position but are not connected. See the following figure.

**Creating Limit Lines**

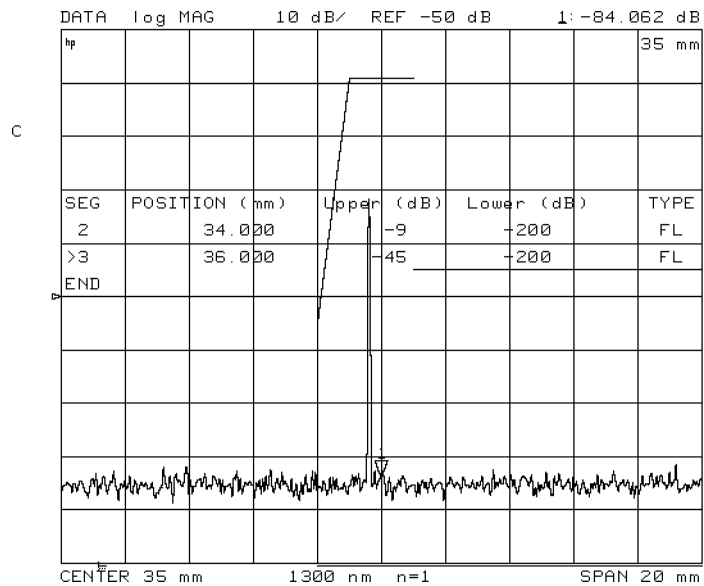

23. Press **ADD**, **DONE**, **LIMIT TYPE**, **SINGLE POINT**, and **RETURN**.

This defines a single-point segment. Note that the single point appears on the screen as just that: a single dot. It is not drawn as a caret because it is defined as a line of no length rather than a single point.

24. Press **ADD**, **POSITION VALUE**, and enter a value of 37 dB.

25. Press **UPPER LIMIT** and then **DONE**.

Note that stand-alone single points are drawn as carets.

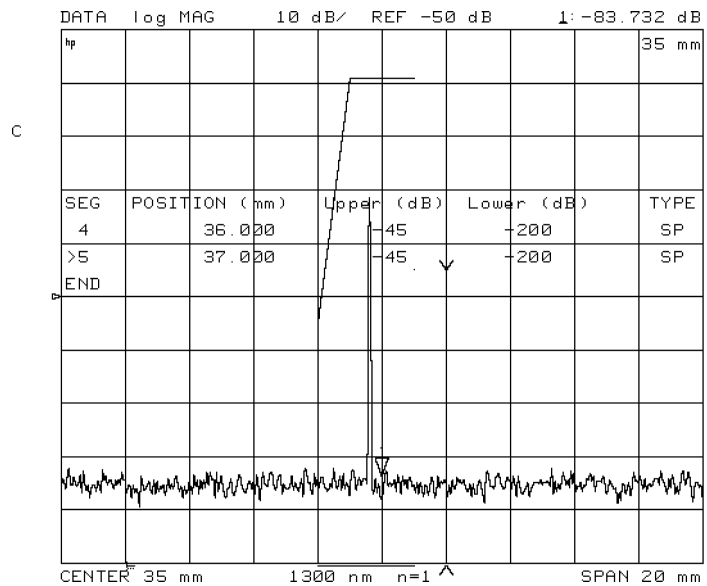

26. Press **DONE** and **LIMIT TEST ON off** to turn on the limit testing.

**Shift the limit segments** 27. Press **LIMIT LINE OFFSETS**, and then **POSITION OFFSET**.

28. Rotate the front-panel knob, and observe that the limit-line segments move back and forth.

The display shows a **PASS** or **FAIL** message depending on whether the peak response or the noise floor intersects one of the limits. Position the limit lines so that the response peak intersects and causes the “FAIL” message.

**Creating Limit Lines**

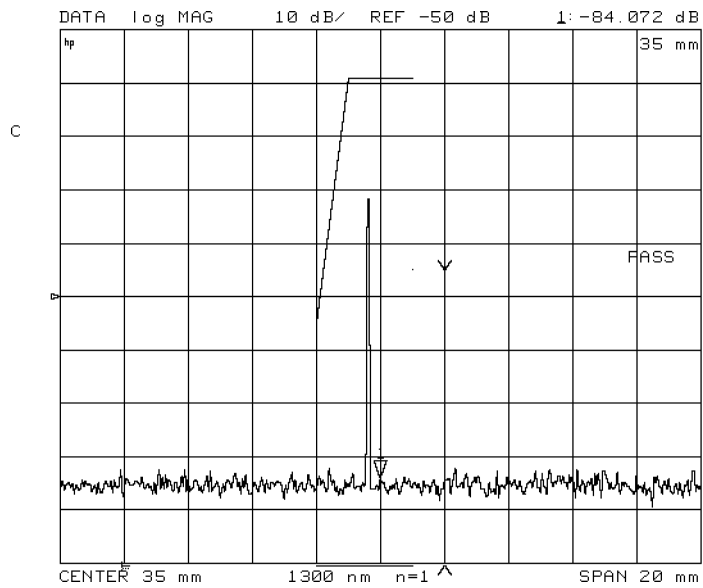

**The PASS message.**

29. Press **AMPLITUDE OFFSET**, and rotate the knob again.

Use the **AMPLITUDE OFFSET** cautiously because although they change the position of the limits they do not change the values in the table. Nor is it evident that the values are offset. Thus results can be misleading.

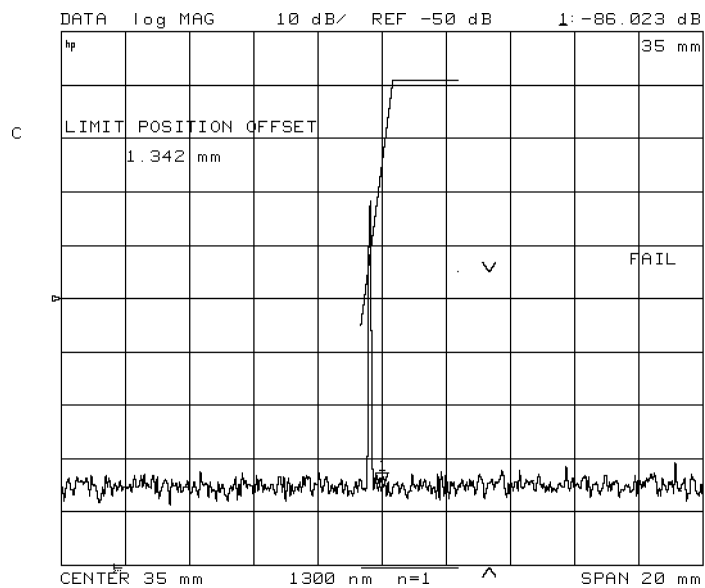

**The FAIL message.**

---

## Storing Traces to Memory

The precision reflectometer places the current measurement data in what is known as the *data* trace. This is the normal displayed trace that is updated with each sweep. You can save the data trace into one of two temporary memory locations: *memory 1* and *memory 2*. (Memory 1 and memory 2 can not be directly updated with each sweep.) You can view the data trace at the same time as a memory trace. You can not view both memory 1 and memory 2 at the same time.

Memory traces are saved in instrument states.

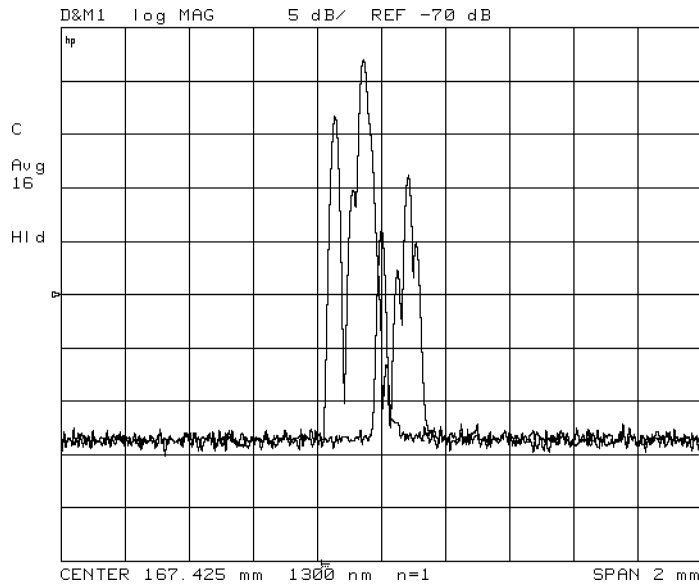

**Both *data* and *memory 1* traces displayed.**



## To view memory traces

1. Press **DISPLAY**.
2. Press **MEMORY 1** or **MEMORY 2** to select the memory trace.
3. Press **DATA → MEMORY 1** to save the data trace to the selected memory trace.
4. Select the traces for display:
  - **DISPLAY: DATA** to display only the data trace.
  - **MEMORY** to display only the memory trace.
  - **DATA and MEMORY 1** to display both traces.

---

# Saving Instrument States to Registers

In this section, you'll learn how to save the instrument state to internal registers. The next section show how to save instrument states to external files on a disk. Instrument states include the following data:

- Measurement data
- Memory traces
- Calibration data (not user-calibration data)
- Learn string

Measurement data can not be saved to an internal register. You can select the type of measurement data saved to an external disk. The following types are available:

- Corrected data (also called data array)
- Uncorrected data (also called raw array)
- Formatted array
- Graphics array

## **What's a learn string?**

The learn string is an encoded array. It contains only the data needed to set up the reflectometer to make a specific measurement. That data consists of stimulus and response parameters and operating mode state, including wavelength and correction status. Learn strings are saved in non-volatile memory. They are not erased by pressing **PRESET** or cycling power.

**Data Stored with Instrument State**

<b>Data Type</b>	<b>Internal Register</b>	<b>External Disk</b>
Learn String	•	•
Measurement Data		•
Trace 1	• <sup>1</sup>	•
Trace 2	• <sup>1</sup>	•
Calibration Data <sup>2</sup>	• <sup>1</sup>	
Limit lines	•	

1 This data is erased when the instrument is turned off or **PRESET** is pressed.

2 This is factory-calibration data and not user-calibration data.

When you save an instrument state to an internal register, memory traces are saved in volatile memory and are erased when one of the following events occurs:

- Instrument power is cycled.
- **PRESET** is pressed.

**How long will data last in an internal register?**

Instrument states last indefinitely as long as the line-power cord supplies power to the instrument. (The instrument does not have to be turned on.) If the instrument is unplugged, internal registers will provide at least 72 hours of safe data storage.

## To save to a register

1. Press **(SAVE)** on the precision reflectometer.
2. Press a **SAVE REG** softkey to save select a register.
3. If you want to use the most recently used file names , press **COPY FROM FILE TITLE** .
4. If you want to create a softkey label for the register, perform the following steps:
  - a. Press **TITLE REGISTER** , and then press a **TITLE REG** softkey to select a register.
  - b. Enter the filename. Turn the front-panel knob to position the arrow on a character. Then, press **SELECT LETTER** .

The first letter must be a letter.

Only letters and numbers are allowed. Do not use mathematical symbols.

Eight is the maximum number of characters.
  - c. Press **DONE** to rename the file.

---

## To recall a register

1. Press **(RECALL)** on the precision reflectometer.
2. Press the softkey corresponding to the register that you want to recall.

## To increase user memory

1. Press **(SAVE)** on the precision reflectometer.
2. Press **CLEAR REGISTER**.
3. Press the **CLEAR REG** softkeys to erase any unneeded registers.

The registers contents are erased.

---

## Saving Instrument States to Files

In order to use a disk, you must have an HP-IB compatible disk drive. Up to 255 instrument-state files can be stored on a disk. Formatting a disk erases all existing data and prepares the disk to store new data. The disk format used by the precision reflectometer is LIF (logical interchange format).

LIF is compatible with HP 9000 Series-300 controllers. LIF is not compatible with most PCs. The reflectometer will not read from, write to, or format disks formatted by PCs, except those having the HP 82300 HP BASIC language processor. For information on transferring data from an LIF disk to a PC-compatible disk, contact your local HP sales and service office.

## To save to a disk

1. Place a formatted disk in the disk drive.

Refer to “To format an external disk” in this section.

2. Press **SAVE** on the precision reflectometer.
3. Press **STORE TO DISK**, **DEFINE STORE**, and then **DISK FILE FORMAT**.
4. Select one of the following data formats:
  - **FORMAT: BINARY** provides faster more compact data storage.
  - **ASCII** save the data in the CITIfile format.

The CITIfile (common instrumentation transfer and interchange file) format is an ASCII format that is useful when data needs to be exchanged with a compatible computer. The following data is stored separately in the file: data arrays, raw data arrays, formatted array, and display memory array.

5. Press **RETURN**.
6. Use the **DATA ARRAY on OFF**, **RAW ARRAY on OFF**, **FORMAT ARY on OFF**, and **GRAPHICS on OFF** softkeys to select which measurement data you want saved in the file. This allows you to save data from different levels in the data processing flow.
7. Press **RETURN**.
8. Press one of the **STORE FILE** softkeys to save the file.

## To change a file name

1. Press **SAVE** on the precision reflectometer.
2. Press **STORE TO DISK** and then **TITLE FILES**.
3. If you want to use the names used in the internal registers, press **READ FILE TITLES**.
4. Press the softkey for the file that you want to rename, and then enter the filename. Turn the front-panel knob to position the arrow on a character. Then, press **SELECT LETTER**.
  - The first letter must be a letter.
  - Only letters and numbers are allowed. Do not use mathematical symbols.
  - Eight is the maximum number of characters.
5. Press **DONE** to rename the file.



---

## To recall an external file

1. Press **RECALL** on the precision reflectometer.
2. Press **LOAD FROM DISK** and then **READ FILE TITLES**.
3. Press **RETURN**.
4. Press a softkey to recall a file.

---

## To delete an external file

1. Press **SAVE** on the precision reflectometer.
2. Press **STORE TO DISK**, **DEFINE STORE**, **PURGE FILES**, and then **READ FILE TITLES**.
3. Press the softkey for the file that you want to delete.

---

## To format an external disk

1. Connect a disk drive as explained in “To connect a disk drive” in this section.
2. Press **SAVE** on the precision reflectometer.
3. Press **STORE TO DISK**, **DEFINE STORE**, **INITIALIZE DISK**, and then **INIT DISK? YES**.

While the disk is being formatted, the message **WAITING FOR DISK** is displayed.

## To connect a disk drive

1. Use an HP-IB cable to connect the disk drive to the precision reflectometer.
2. Press **LOCAL** on the precision reflectometer.
3. Press **SYSTEM CONTROLLER** so that the precision reflectometer can control the disk drive.
4. Press **SET ADDRESSES**.

The display shows the current address for the external disk drive. The default address is 00.

5. Press **ADDRESS DISK**, and enter the new address if the displayed address does not match the disk drive's actual address.
6. Press **(x1)** to enter the new address.
7. Press **RETURN**.
8. Press **DISK UNIT NUMBER**, enter the unit number, and press **(x1)**.

The unit number is typically 0 or 1 and refers to an individual disk drive slot.

9. Press **VOLUME NUMBER**, enter the volume number, and press **(x1)**.

Volume numbers are used for hard disk drives. So, for reading disks, the volume number should be 0.

---

# Changing Colors and Audible Warnings

The precision reflectometer uses colors to highlight the difference between data and memory traces, the reference line, the graticule, warning text, and annotation. You can change the color, tint, and brightness of each of these items.

An audible “beep” sounds each time you save an instrument state or place a trace into memory. You can prevent this beep from sounding. In addition, the instrument can be configured so that a “beep” sounds each time that a cautionary message is displayed on the screen.

---

## To adjust displayed colors

1. Press **DISPLAY**.
2. Press **MORE** and then **ADJUST DISPLAY**.
  - Press **INTENSITY**, **BACKGROUND INTENSITY**, and **MODIFY COLORS** to adjust the display.
  - Press **SAVE COLORS** softkey to save your custom colors.
  - Press **DEFAULT COLORS** to return the display to factor default values.

---

## To turn on the warning beep

1. Press **DISPLAY**.
2. Press **MORE** and then **BEEP WARN on OFF** so that **ON** is highlighted.

## To turn off the “done” beep

1. Press **DISPLAY**.
2. Press **MORE** and then **BEEP DONE ON off** so that **OFF** is highlighted.

---

# Printing and Plotting

In this section, you'll learn how to create prints or plots of the following information for reports or records:

- Hard copies of the display.
- Tables of measured stimulus points.
- Tables of instrument parameters.

Plots can be made on any Hewlett Packard HP-GL plotter. Prints can be made on any Hewlett Packard graphics printer. The printer or plotter must have an HP-IB connector. The following printers support the Hewlett Packard PCL printer language:

- ThinkJet
- PaintJet
- LaserJet

For more information on printing and plotting, refer to the softkey definitions in Chapter 5.

## To print the display

1. Connect the printer to the precision reflectometer using an HP-IB cable.
2. Enter the printer's address and type as described in "To enter the printer/plotter type and address" in this section.
3. Press **COPY**.
4. Press **SELECT QUADRANT**, and select the portion of the printer paper to place the image on.
5. Press **PRINT/PLOT SETUPS** and select one of the following:
  - **STANDARD** for a black and white printer.
  - **COLOR** for a color printer.
6. Press **COPY** and then **PRINT**.

---

## To plot the display

1. Connect the plotter to the precision reflectometer using an HP-IB cable.
2. Enter the plotter's address and type as described in "To enter the printer/plotter type and address" in this section.
3. Press **COPY**.
4. Press **SELECT QUADRANT**, and select the portion of the plotter paper to place the image on.
5. Use the **DEFINE PLOT** and **CONFIGURE PLOT** menus to define the plotted image.
6. Press **COPY** and then **PLOT**.

---

## To print or plot measurement and parameter values

1. Connect the plotter or printer to the precision reflectometer using an HP-IB cable.
2. Enter the plotter or printer's address and type as described in "To enter the printer/plotter type and address" in this section.
3. Press **COPY** and make one of the following selections:

- **LIST VALUES** prints or plots a table of all measured stimulus points and their current data values. Limit information is included if it is turned on.

Up to five columns of information are provided. The specific information listed for each measured stimulus point varies depending on the display format and the limit testing status. If limit testing is on, an asterisk \* is listed next to any measured value that is out of limits. If limit lines are on, and other listed data allows sufficient space, the limits are listed together with the margin by which the device data passes or fails the nearest limit.

- **OP PARMS (MKRS etc)** prints or plots a table of key parameters.
4. Press **COPY** and then **PRINT** or **PLOT**.

---

## To enter the printer/plotter type and address

1. Press **LOCAL**.
2. Press **SYSTEM CONTROLLER**.
3. Press **SET ADDRESSES**.

The display shows the default address for any printer or plotter. Plotters are normally set to address 05. Printers are normally set to address 01.

## Performing Measurements

4. If the displayed HP-IB address of the printer does not match the printer's actual address, press **ADDRESS PRINTER**, and enter the correct address.
5. If the displayed HP-IB address of the plotter does not match the plotter's actual address, press **ADDRESS PLOTTER**, and enter the correct address.
6. Press **(x1)** to enter the new address.

---

### To abort a print or plot

1. Press **(LOCAL)**.
2. Press **TALKER/LISTENER**.



**Programming**

---

# Programming

This chapter shows you how to prepare the instrument for programming and send and receive programming commands, and documents each precision reflectometer command.

During remote control, four front-panel indicator lights show the current HP-IB (Hewlett-Packard Interface Bus) status. These indicators are defined in the following table.

**Displayed Status Indicators**

<b>LED Indicator</b>	<b>HP-IB Mode</b>
R	Remote operation
L	Listen mode
T	Talk mode
S	Service request (SRQ) status

You can return the reflectometer to local (front panel) operation at any time by pressing the **LOCAL** key. This is the only front-panel key that is not disabled when the reflectometer is remotely controlled over HP-IB by a computer.

**Contents**

Controlling the Instrument .....	4-4
To select the HP-IB mode .....	4-8
To change the HP-IB address .....	4-8
Monitoring the Instrument .....	4-9
IEEE 488.2 Common Commands .....	4-12
Instrument Commands .....	4-15
Keys versus Commands .....	4-54

---

# Controlling the Instrument

## Three HP-IB modes are available

The precision reflectometer can be set to one of three HP-IB modes:

- Talker/listener
- System controller
- Pass control

The **PRESET** key does not affect the selected controller mode, but cycling the power returns the precision reflectometer to the talker/listener mode.

The *talker/listener* mode is the normal mode of operation. In this mode, a computer controller communicates with the precision reflectometer and other instruments over the bus. The computer sends commands or instructions to and receives data from the precision reflectometer. All of the capabilities available from the precision reflectometer's front panel can be used in this remote operation mode, except for control of the power line switch and the reference polarization balance knobs.

In *system controller* mode, the reflectometer itself can use HP-IB to control compatible peripherals without the use of an external computer. It can output measurement results directly to a compatible printer or plotter, and store instrument states using a compatible disk drive.

In *pass control* mode, the controller can pass control of the bus to the precision reflectometer on request from the precision reflectometer. The precision reflectometer is then the controller of the peripherals, and can direct them to plot, print, or store without going through the computer. When the peripheral operation is complete, control is passed back to the computer. Only one controller can be active at one time. The computer remains the system controller and can regain control at any time.

## Set the HP-IB address from the front panel

In HP-IB communications, each instrument on the bus is identified by an HP-IB address. This decimal-based address code must be different for each instrument on the bus. Most of the HP-IB addresses are set at the factory and need not be modified for normal system operation.

**Default HP-IB Addresses**

<b>Instrument</b>	<b>Address (decimal)</b>
HP 8504	16
Plotter	05
Printer	01
External Disk Drive	00
Controller	21

You can change the default HP-IB addresses used by the precision reflectometer from the front panel. These addresses are stored in short-term non-volatile memory and are not affected by preset or by cycling the power.

**NOTE**

The reflectometer does not have an HP-IB address switch.

**Use the debugging feature**

The first time a program is run, you should enable the precision reflectometer's debugging feature. When this feature is on, the reflectometer scrolls a history of incoming HP-IB commands across the display in the title line. Non-printable characters are represented as  $\pi$ . Any time a syntax error is received, the commands stop and a pointer indicates the misunderstood character. To turn on the debugging feature, press **LOCAL** and then **HP-IB DIAG on OFF**.

**Controlling the Instrument****Send commands as ASCII strings**

Commands are sent to the precision reflectometer as ASCII strings. The method used depends on the programming language and environment. Using an HP Vectra computer with the HP-IB Interface and Command Library (and programming in C), send a command as follows:

```
iooutputs(716L, "PRES;", 5);
```

Using an HP 9000 Series 300 technical computer with the HP-BASIC language, the same command would be sent as follows:

```
OUTPUT 716;"PRES;"
```

Use a semicolon (;) to terminate each input string of program commands. A line feed can also serve as a terminator. For example, either of the following is acceptable.

```
OUTPUT 716;"PRES;CLEARALL;"
```

```
OUTPUT 716;"PRES;CLEARALL"
```

**Returning data to the controller**

Some precision reflectometer commands can be issued as a query. A query causes data to be returned to the computer from the instrument. The data is returned as an ASCII string. Queries are formed by adding the question mark (?) character to the command. Refer to the command listing in this chapter to determine if a command can be used as a query. syntax listed for each command .

For example, sending the following command turns the HP-IB command debug mode on:

```
OUTPUT 716;"DEBUOFF;"
```

Upon receiving this command, the precision reflectometer sends a "1" to the computer. (A "1" indicates an "on" condition; a "0" indicates an "off" condition.)

Querying a settable functions such as **SCAL**, returns the current function value then clears the instrument entry area. Querying a command that does not have a defined response returns a zero. The following example returns a value to the computer and then prints the value:

```
OUTPUT Hp8504;"SCAL?;"
ENTER Hp8504;Scale
PRINT Scale
```

**Use suffixes to specify units**

The following suffixes can be used as units. If no suffix is used, the precision reflectometer assumes the default values for the instruction. Upper and lower case characters are equivalent.

Distance .....MM, UM (microns), NM  
 Return Loss .....DB  
 Time .....S (default), MS, US (microseconds), NS, PS, FS

**How command names are determined**

The HP-IB Commands are derived from their front panel key titles (where possible), according to the naming conventions below. Some commands require arguments (for example, on, off, 1, 2). Where possible, the HP 8504 reflectometer commands are compatible with HP 8702 and HP 8703 lightwave component analyzer commands.

**HP-IB Command Naming Convention**

Convention	Letters Used in Command	Example	
		Key Title	HP-IB Code
One word	First four letters	CORRECTION	CORR
Two words	First three letters of first word and first letter of second word	ZERO SPAN	ZERS
		MAX SEARCH	MAXS
Two words in a group	First four letters of both	MARKER → CENTER	MARKCENT

## To select the HP-IB mode

1. Press **LOCAL**.
2. Press one of the following softkeys: **SYSTEM CONTROLLER**, **TALKER/LISTENER**, or **USE PASS CONTROL**.

---

## To change the HP-IB address

1. Press **LOCAL**.
2. Press **SET ADDRESSES**.

The display shows the current address for the precision reflectometer.

3. Press **ADDRESS HP8504**, and enter the new address.
4. Press **x1** to enter the new address.



---

# Monitoring the Instrument

The following figures show the instrument's status reporting registers. These registers allow you to monitor the instrument's operating condition during a program. Use the **\*STB?** common command to read the status byte. (**\*CLS** clears the status byte; **\*SRE** enables status-byte bits.) Use the **\*ESR?** common command to read the standard event status register. Refer to "IEEE 488.2 Common Commands" in this chapter for information on common commands.

## Status Byte Bit Definitions

Bit	Name	Description
2	Check event status register B	One of the enabled bits in event status register B has been set.
3	Message in error queue	An error has occurred and the message has been placed in the error queue, but has not been read yet.
4	Message in output queue	A command has prepared information to be output, but it has not been read yet.
5	Check event status register	One of the enabled bits in the event status register has been set.
6	Request service	One of the enabled status byte bits is causing an SRQ.

**Monitoring the Instrument****Event Status Register Bit Definitions**

<b>Bit</b>	<b>Name</b>	<b>Description</b>
0	Operation complete	A command for which OPC has been enabled and completed an operation.
1	Request control	The reflectometer has been commanded to perform an operation that requires control of a peripheral, and needs control of HP-IB. Requires the reflectometer to be in use pass control mode.
2	Query error	The reflectometer has been addressed to talk, but there is nothing in the output queue to transmit.
4	Execution error	A command was received that could not be executed. Commonly due to invalid operands, or operands sent in the wrong sequence.
5	Syntax error	An HP-IB command had incorrect syntax error [spelling or use].
6	User request	The operator has pressed a front panel key or turned the rotary knob. This bit is set regardless of whether the reflectometer is in remote or local.
7	Power on	A power on sequence has occurred since the last read of the register.

**Event Status Register B Bit Definitions**

<b>Bit</b>	<b>Name</b>	<b>Description</b>
0	Sweep or group complete	A single sweep or group has been completed since the last read of the register. Operates in conjunction with the SING or NUMG commands.
1	Service routine waiting or done	An internal service routine has completed an operation, or is waiting for an operator response.
2	Data entry complete	A terminator key has been pressed, or a value has been inputted to the reflectometer over HP-IB.
4	Limit failed	Limit test failed.
6	Search failed	A marker search was executed, but the target value was not found.
7		

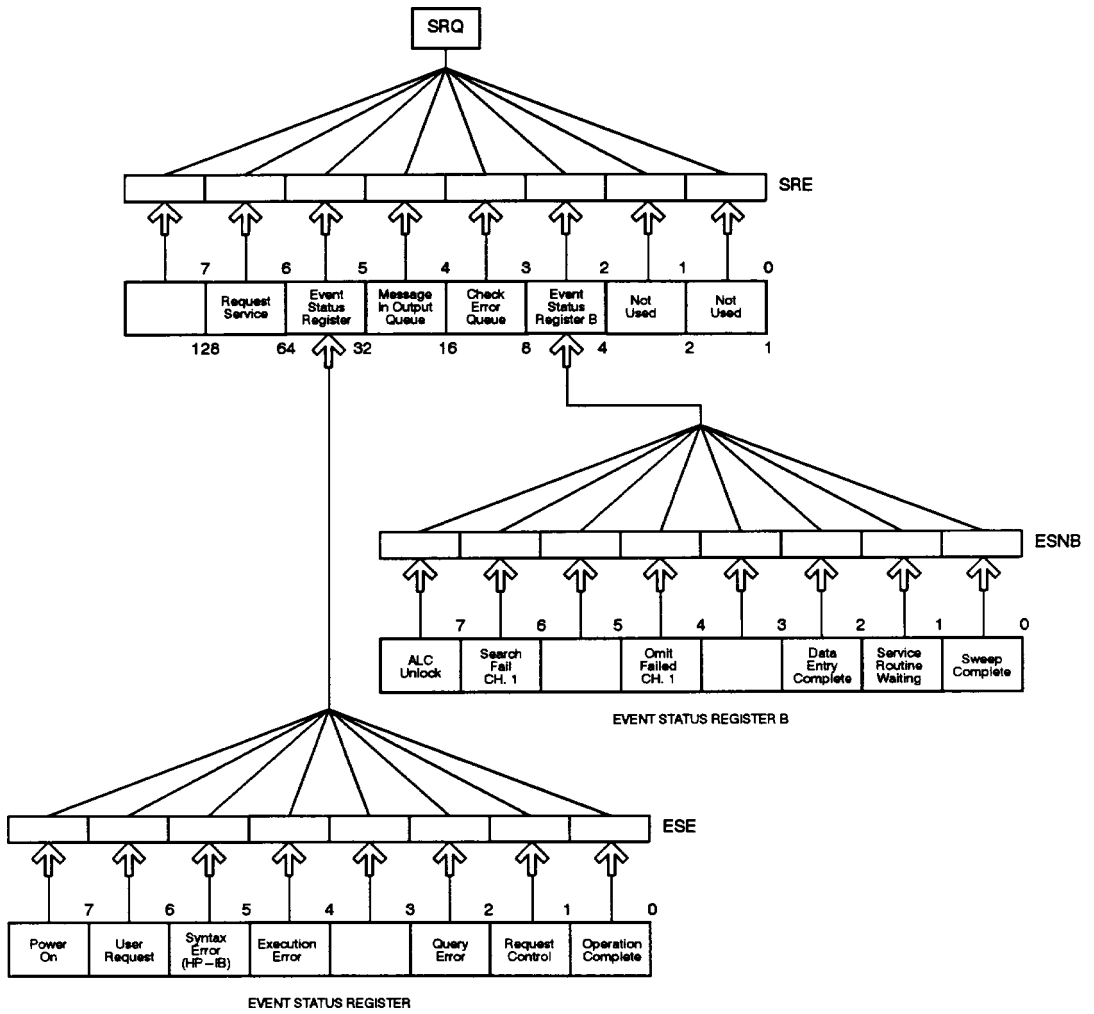

Status Reporting Registers

---

**IEEE 488.2  
Common  
Commands**

The following syntax notation conventions are used in this section:

CAPITAL LETTERS	Capital letters indicate the short form of a command. The actual command is not case sensitive and can be entered in upper or lower case.
< >	Characters appearing in angular brackets indicate a constant, a pre-assigned simple or complex numeric variable, or string variable transferred to the reflectometer. A space may be inserted between it and the command.
[ ]	Square brackets indicate that whatever occurs within the brackets is optional.
{ }	Braces are used to clarify which elements are to be chosen from.
	“Or” indicates a choice of exactly one element from a list (for example, <a> <b> indicates <a> or <b> but not both).

\***CLS** Clears the status byte, the event status register, and the event status register B.

Syntax: \*CLS

\***ESE** Enables specific bits of event status register. Query

Syntax: \*ESE{?|<value>}

Item	Description
value	0 to 32767   $2^{15-1}$

\***ESR?** Returns the contents of the standard event status register.

Syntax: \*ESR?

\***IDN?** Outputs the identification string, "HEWLETT PACKARD, 8504A,0,X.XX", where X.XX is the firmware revision.

Syntax: \*IDN?

\***OPC** Tells the reflectometer to set bit 0, (Operation Complete bit), in the event status register when it completes all pending operations. When used in Query form, the reflectometer will output a 1 when the operation is complete.

Its use is enabled by issuing the command OPC; or OPC?; prior to an OPC'able command. For example, issuing OPC;SING; causes the OPC bit in to be set at the completion of the single sweep. Issuing OPC?; instead causes the reflectometer to output a 1 when the sweep is completed. Addressing the reflectometer to talk will then hold HP-IB traffic until the sweep is completed and the "1" has been accepted.

Syntax: \*OPC

\***PCB** Sets the HP-IB address which the reflectometer uses to communicate with an external controller.

Syntax: \*PCB{?|<value>}

Item	Description
value	0 to 30, default 21.

Equivalent softkey: **LOCAL**, ADDRESS: CONTROLLER

\***RST** Sets the reflectometer to the factory preset condition.

Syntax: \*RST or PRES

Equivalent key: **PRESET**

\***SRE** Service request enable. The value is the mask which enables specific bits in the status byte for generating an SRQ.

Syntax: \*SRE{?|<value>}

\***STB?** Reads the status byte.

Syntax: \*STB?

\***TST?** Executes an internal self-test and returns the test result (0 = pass, 1 = fail.)

Syntax: \*TST?

## Instrument Commands

The following syntax notation conventions are used in this section:

CAPITAL LETTERS	Capital letters indicate the short form of a command. The actual command is not case sensitive and can be entered in upper or lower case.
< >	Characters appearing in angular brackets indicate a constant, a pre-assigned simple or complex numeric variable, or string variable transferred to the reflectometer. A space may be inserted between it and the command.
[ ]	Square brackets indicate that whatever occurs within the brackets is optional.
{ }	Braces are used to clarify which elements are to be chosen from.
	“Or” indicates a choice of exactly one element from a list (for example, <a> <b> indicates <a> or <b> but not both).

## Commands without Equivalent Softkeys

CLES	KEY	OUTPKEY
ESB?	KOR?	OUTPLIMF
ESNB	LRN	OUTPLIML
FORM1	MARKBUCK	OUTPLIMM
FORM2	MENU	OUTPMARK
FORM3	NOOP	OUTPMEMO
FORM4	NUMG	OUTPPLOT
FORM5	OUTPACI	OUTPPRIN
INPUTDATA	OUTPDATA	OUTPRAW1
INPUFORM	OUTPERRO	OUTPTITL
INPULEAS	OUTPFORM	WAIT
INPURAW1	OUTPIDEN	

**Instrument Commands**

**ADDRCONT** Sets the HP-IB address which the reflectometer uses to communicate with an external controller. This command is identical to the **PCB** command.

Syntax: ADDRCONT {?|<value>}

Item	Description
value	0 to 30, default 21.

Equivalent softkey: **LOCAL**, ADDRESS: CONTROLLER

**ADDRDISK** Sets the HP-IB address which the reflectometer uses to communicate with an external disk drive.

Syntax: ADDRDISK{?|<value>}

Item	Description
value	0 to 30, default 0.

Equivalent softkey: **LOCAL**, ADDRESS: DISK

**ADDRPLOT** Sets the HP-IB address which the reflectometer uses to communicate with a plotter.

Syntax: ADDRLOT{?|<value>}

Item	Description
value	0 to 30, default 5.

Equivalent softkey: **LOCAL**, ADDRESS: PLOTTER

**ADDRPRIN** Sets the HP-IB address which the reflectometer uses to communicate with the printer.

Syntax ADDRPRIN{?|<value>}



Item	Description
value	0 to 30, default 1.

Equivalent softkey: **LOCAL**, ADDRESS: PRINTER

**AUTO** Selects the scale/div value automatically to fit the trace data to the display.

Syntax **AUTO**

Equivalent softkey: **SCALE REF**, AUTO SCALE

**AVERFACT** Sets the averaging factor.

Syntax **AVERFACT**{?|<value>}

Item	Description
value	1 to 999.

Equivalent softkey: **AVG**, AVERAGING FACTOR

**AVERO** Sets the averaging function on or off.

Syntax **AVERO**{ON|OFF|?}

Equivalent softkey: **AVG**, AVERAGING on OFF

**AVERREST** Resets and restarts averaging.

Syntax **AVERREST**

Equivalent softkey: **AVG**, AVERAGING RESTART

**BACI** Sets the background intensity of the display as a percent of the white level.

Syntax **BACI**{?|<value>}

Item	Description
value	0 to 100 %

Equivalent softkey: **DISPLAY**, **BACKGROUND INTENSITY**

**BALD** Saves results of receiver balance.

Syntax **BALD**

Equivalent softkey: **CAL**, **DONE**

**BALE** Exits receiver balance before completion.

Syntax **BALE**

Equivalent softkey: **CAL**, **EXIT**

**BALR** Initiates receiver balance and measures offsets.

Syntax **BALR**

Equivalent softkey: **DISPLAY**, **BALANCE RECEIVER**

**BEEPDONE** Sets the operation completion beeper on or off.

Syntax **BEEPDONE**{ON|OFF|?}

Equivalent softkey: **DISPLAY**, **BEEP DONE on off**

**BEEPFAIL** Sets the limit fail beeper on or off.

Syntax **BEEPFAIL**{ON|OFF|?}

Equivalent softkey: **SYSTEM**, **BEEP FAIL on off**

**BEEPWARN** Sets the warning beeper on or off.

Syntax **BEEPWARN**{ON|OFF|?}

Equivalent softkey: **DISPLAY**, **BEEP WARN on off**

**CALD** Measures magnitude calibration standard.

Syntax **CALD**

Equivalent softkey: **CAL**, **MEASURE STANDARD**

**CALE** Exits magnitude calibration before completion.

Syntax **CALE**

Equivalent softkey: **CAL**, **EXIT**

**CALM** Initiates magnitude calibration.

Syntax **CALM**

Equivalent softkey: **CAL**, **CALIBRATE MAGNITUDE**

**CALFRES** Specifies default Fresnel standard as calibration standard.

Syntax **CALFRES**

Equivalent softkey: **CAL**, **CALIBRATE MAGNITUDE**

**CALUSER** Specifies user defined standard as calibration standard.

Syntax **CALUSER**

Equivalent softkey: **CAL**, **CALIBRATE MAGNITUDE**

**CBRI** Sets the color brightness in percent. See COLO below.

Syntax **CBRI**{?|<value>}

Item	Description
value	0 to 100 %

Equivalent softkey: **DISPLAY**, **BRIGHTNESS**

**CENT** Sets the center stimulus value.

Syntax **CENT** <value> [suffix]

Item	Description
value	Domain dependent
suffix	DB, MM, UM, NM, S, MS, US, NS, PS, FS

Equivalent softkey: **MENU**, **CENTER**

**CLEA** Clear the save/recall register 1-5.

Syntax **CLEA**{1|2|3|4|5}

Equivalent softkey: **SAVE**, **CLEAR REG1-5**

**CLEARALL** Clears all five save/recall registers.

Syntax **CLEARALL**

Equivalent softkey: **SAVE**, **CLEAR ALL**

**CLES** Clears the status byte, the event status register, and the event status register B.

Syntax **CLES**

**CLS** Clears the status byte, the event status register, and the event status register B.

Syntax **CLS**

**COLO** Specifies the display element to change color data and limit lines, memory 1, memory 2, the graticule, text, or warning messages. The color changes are accomplished by the commands CBRI, COLOR, and TINT. See those commands for more details.

Syntax **COLO**{DATA|MEM1|MEM2|GRAT|TEXT|WARN}

Equivalent softkey: **DISPLAY**, **DATA LIMIT LN**, **MEMORY 1**,  
**MEMORY 2 REF LINE**, **GRATICULE TEXT**, **WARNING**, and **TEXT**

**COLOR** Specifies the saturation percent of the specified display format. See COLO above.

Syntax **COLOR**{?|<value>}

Item	Description
value	0 to 100 %

Equivalent softkey: **DISPLAY**, **COLOR**

**CONT** Continuous trigger.

Syntax **CONT**

Equivalent softkey: **MEAS**, **CONTINUOUS**

**COPYFRFT** Copies the disk file titles into the register titles.

Syntax **COPYFRFT**

Equivalent softkey: **SAVE**, **COPY FROM FILE TITLE**

**COPYFRRT** Copies the register titles into the disk file titles.

Syntax **COPYFRRT**

Equivalent softkey: **SAVE**, **COPY FROM REG TITLES**

**CORR** Sets the correction function on or off.

Syntax **CORR**{ON|OFF|?}

Equivalent softkey: **CAL**, **CORRECTION on OFF**

**DATI** Stores the corrected data to trace memory.

Syntax **DATI**

Equivalent softkey: **DISPLAY**, **DATA → MEM**

**DEBU** Turns the HP-IB command debug mode on or off. When on, the commands are scrolled through the top portion of the display.

Syntax **DEBU**{ON|OFF|?}

Equivalent softkey: **LOCAL**, **HP-IB DIAG on OFF**

**DEFC** Returns all traces, lines, and text to the default colors.

Syntax **DEFC**

Equivalent softkey: **LOCAL**, **DEFAULT COLORS**

**DELO** Sets the delta marker mode off.

Syntax **DELO**

Equivalent softkey: **MKR**, **Δ MODE OFF**

**DELR** Sets the indicated marker as the delta reference.

Syntax **DELR**{1|2|3|4}

Equivalent softkey: **MKR**, **Δ REF = 1** to **Δ REF = 4**

**DELRFIXM** Sets the user-specified fixed marker as the delta reference.

Syntax **DELRFIXM**

Equivalent softkey: **MKR**, **Δ REF = Δ FIXED MKR**

**DFLT** Returns the plotting parameters to the default values.

Syntax **DFLT**

Equivalent softkey: **COPY**, **PRINT/PLOT SETUPS**, **DEFAULT SETUP**

**DISKUNIT** Specifies the disc unit in a multiple-disk drive for disk store/load. For example, in a two floppy disk drive, the left-hand drive is unit number 0, the right-hand is unit number 1.

Syntax **DISKUNIT** <unit number>

Equivalent softkey: **LOCAL**, **DISK UNIT NUMBER**

**DISKVOLU** Specifies the volume number in a disk drive that allows multiple volumes for disk store/load.

Syntax **DISKVOLU** <volume number>

Equivalent softkey: **LOCAL**, **DISK UNIT NUMBER**

**DISM** Enable/disable the display of all markers that have been individually turned on below active marker area (upper right-hand corner of display).

Syntax **DISM**{ON|OFF|?}

Equivalent softkey: **MKR**, **DISP MKRS ON off**

**DISPCOR** Enable/disable dispersion correction of data taken with 1550 nm source selected.

Syntax **DISPCOR**{ON|OFF|?}

Equivalent softkey: **CAL**, **DISPER COR**

**DISPDATA** Displays a trace of the measured data.

Syntax **DISPDATA**

Equivalent softkey: **DISPLAY**, **DISPLAY DATA**

**DISPDATM** Displays traces of both the measured data and the memory data.

Syntax **DISPDATM**

Equivalent softkey: **DISPLAY**, **DATA and MEMORY**

**DISPMEMO** Displays the trace of the memory data.

Syntax **DISPMEMO**

Equivalent softkey: **DISPLAY**, **MEMORY**

**DIST** Formats the horizontal axis as distance.

Syntax **DIST**

Equivalent softkey: **DISPLAY**, **HORIZ. DISTANCE**

**DOWN** Decrements the value in the active entry area. Down arrow key in the **ENTRY** area.

Syntax **DOWN**

**EDITLIML** Begins editing the limit line table.

Syntax **EDITLIML**

Equivalent softkey: **SYSTEM**, **EDIT LIMIT LINE**

**ENTO** Turns off the active entry area.

Syntax **ENTO**

**ESB?** Returns the event status register B value.

Syntax **ESB?**



**ESE** Enables specific bits of event status register. Query

Syntax **ESE**{?**|**<value>**}**

Item	Description
value	0 to 32767   $2^{15-1}$  .

**ESNB** Enables specific bits of event status register B.

Syntax **ESNB**{?**|**<value>**}**

Item	Description
value	0 to 32767   $2^{15-1}$  .

**ESR?** Returns the event status register value.

Syntax **ESR?**

**EXTMDATA** Enable/disable storage of corrected data when a file is stored to disk.

Syntax **EXTMDATA**{**ON**|**OFF**|**?**}

Equivalent softkey: **SAVE**, **DEFINE**, **INIT**, **PURGE**, **DATA ARRAY on OFF**

**EXTMFORM** Enable/disable storage of formatted data when a file is stored to disk.

Syntax **EXTMFORM**{**ON**|**OFF**|**?**}

Equivalent softkey: **SAVE**, **DEFINE**, **INIT**, **PURGE**, **FORMAT ARY on OFF**

**EXTMGRAP** Enable/disable storage of user graphics when a file is stored to disk.

Syntax **EXTMGRAP**{**ON**|**OFF**|**?**}

Equivalent softkey: **SAVE**, **DEFINE**, **INIT**, **PURGE**, **GRAPHICS on OFF**

**EXTMRAW** Enable/disable storage of raw data arrays when a file is stored to disk.

Syntax **EXTMRAW**{ON|OFF|?}

Equivalent softkey: **SAVE**, **DEFINE**, **INIT**, **PURGE**, **DATA ARRAY on OFF**

**EXTT** Enable/disable the external measurement trigger mode.

Syntax **EXTT**{ON|OFF|?}

Item	Description
value	1 to 200, default 1.

Equivalent softkey: **MEAS**, **TRIGGER TRIG OFF**

**FORM1** Sets the format for data transfer to the reflectometer's internal format.

Syntax **FORM1**

**FORM2** Sets the format for data transfer to the IEEE 32-bit floating point.

Syntax **FORM2**

**FORM3** Sets the format for data transfer to the IEEE 64-bit floating point.

Syntax **FORM3**

**FORM4** Sets the format for data transfer to ASCII.

Syntax **FORM4**

**FORM5** Sets the format for data transfer to the IEEE 32-bit floating point, but with least significant byte of each point sent first, for compatibility with PC-DOS memory management.

Syntax **FORM5**

**FULP** Selects the full page plot.

Syntax **FULP**

Equivalent softkey: **COPY**, **FULL PAGE**

**FULS** Specifies full span (distance or time) sweep (minimum to maximum).

Syntax **FULS**

Equivalent softkey: **MENU**, **FULL SPAN**

**GUIC** Initiates guided calibration. Receiver balance is performed first and is followed by magnitude calibration.

Syntax **GUIC**

Equivalent softkey: **CAL**, **GUIDED CAL**

**GUIS** Initiates guided setup, a series of screens with prompts to set up and calibrate the reflectometer.

Syntax **GUIS**

**GROI** Sets value of  $n$ , group index of refraction, of the medium under test. Rescales horizontal axis when distance format is selected. This command is equivalent to the **INDEREFR** command.

Syntax **GROI**{?|<value>}

**HOLD** Sets the trigger mode to hold the current measurement.

Syntax **HOLD**

Equivalent softkey: **MEAS**, **TRIGGER HOLD**

**Instrument Commands**

**INDEREFR** Sets value of *n*, group index of refraction, of the medium under test. Rescales horizontal axis when distance format is selected. This command is equivalent to the **GROI** command.

Syntax **INDEREFR**{?|<value>}

**IDN?** Outputs the identification string, **HEWLETT PACKARD, 8504A,0,X.XX**, where **X.XX** is the firmware revision. This command is identical to the **OUTPIDEN** command.

Syntax **IDN?**

**INID** Initializes the disk Logical Interchange Format, LIF.

Syntax **INID**

Equivalent softkey: **MEAS**, **INITIALIZE DISK**

**INPUDATA** Inputs the error corrected data. The reflectometer will stop sweeping and display the data.

Syntax **INPUDATA**{?|<value>}

Item	Description
value	Complex number. Data format data, 0

**INPUFORM** Inputs formatted data. The reflectometer will stop sweeping and display the data.

Syntax **INPUFORM**{?|<value>}

Item	Description
value	Complex number. Data format data, 0

**INPULEAS** Input a learn string, previously obtained by the **OUTPLEAS** command. This command is equivalent to the **LRN** command.

Syntax **INPULEAS**{?|<value>}

**INPURAW1** Inputs raw data. The reflectometer will stop sweeping and display the data.

Syntax **INPURAW1**{?|<value>}

Item	Description
value	Complex number. Data format data1, data2

**INTE** Sets the display intensity as a percent of the brightest setting.

Syntax **INTE**{?|<value>}

Item	Description
value	0 to 100 %.

Equivalent softkey: **DISPLAY**, **INTENSITY**

**Instrument Commands**

**KEY** Inputs the key code for a hardkey or a softkey on the front panel. This is equivalent to actually pressing a key.

Syntax KEY{?|<value>}

Item	Description
value	0 to 49.

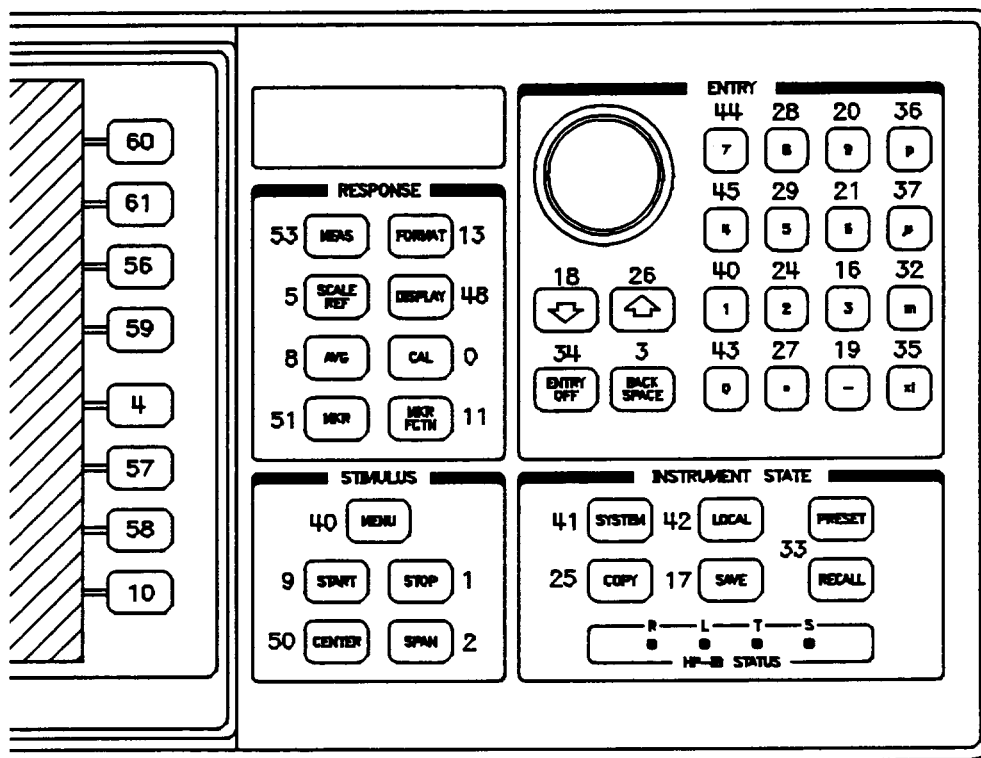

Key Codes

**KOR?** Outputs a two byte key code or knob count. If the number is positive (two's complement), the number is a key code; if negative, the number is an encoded knob count. The knob count is decoded by clearing (set to zero) the first of the two bytes if bit 6 of the first byte is 0. The resulting combined value of the two bytes is the knob count, positive or negative depending on whether the knob was turned counterclockwise or clockwise, respectively.

Syntax **KOR?**

**LEFL** Sets the plot quadrant to left lower.

Syntax **LEFL**

Equivalent softkey: **COPY**, **LEFT LOWER**

**LEFU** Sets the plot quadrant to left upper.

Syntax **LEFU**

Equivalent softkey: **COPY**, **LEFT UPPER**

**LIMD** Sets the limits delta value from the specified middle value.

Syntax **LIMD** <value> [suffix]

Item	Description
value	Format dependent.
suffix	DB, MM, UM, NM, S, MS, US, NS, PS, FS

Equivalent softkey: **SYSTEM**, **DELTA LIMITS**

**LIMIAMPO** Sets an amplitude offset value for limit testing.

Syntax **LIMIAMPO** <value> [suffix]

Item	Description
value	Format dependent.
suffix	DB, MM, UM, NM, S, MS, US, NS, PS, FS

**Instrument Commands**

Equivalent softkey: **(SYSTEM)**, **AMPLITUDE OFFSET**

**LIMILINE** Sets limit lines on or off.

Syntax **LIMILINE**{ON|OFF|?}

Equivalent softkey: **(SYSTEM)**, **LIMIT LINE on off**

**LIMIMAOF** Sets the active marker value to the amplitude offset for limit testing.

Syntax **LIMIMAOF**

Equivalent softkey: **(SYSTEM)**, **MARKER → AMP. OFS**

**LIMIPOS0** Sets a position offset value for limit testing.

Syntax **LIMIPOS0** <value> [suffix]

Item	Description
<b>value</b>	Domain dependent.
<b>suffix</b>	DB, MM, UM, NM, S, MS, US, NS, PS, FS

Equivalent softkey: **(SYSTEM)**, **POSITION OFFSET**

**LIMITEST** Sets the limit testing on or off.

Syntax **LIMITEST**{ON|OFF|?}

Equivalent softkey: **(SYSTEM)**, **LIMIT TEST on off**

**LIML** Sets the lower limit value for a limit testing segment.

Syntax **LIML** <value> [suffix]

Item	Description
<b>value</b>	Format dependent.
<b>suffix</b>	DB, MM, UM, NM, S, MS, US, NS, PS, FS

Equivalent softkey: **(SYSTEM)**, **LOWER LIMIT**



**LIMM** Sets the middle value of delta limits.

Syntax **LIMM** <value> [suffix]

Item	Description
value	Format dependent.
suffix	DB, MM, UM, NM, S, MS, US, NS, PS, FS

Equivalent softkey: **SYSTEM**, **MIDDLE VALUE**

**LIMP** Sets the starting position value of a limit testing segment.

Syntax **LIMP** <value> [suffix]

Item	Description
value	Domain dependent.
suffix	DB, MM, UM, NM, S, MS, US, NS, PS, FS

Equivalent softkey: **SYSTEM**, **POSITION VALUE**

**LIMIT** Specifies the limit type as a flat line, sloping line, or single point segment.

Syntax **LIMIT**{FL|SL|SP}

Equivalent softkey: **SYSTEM**, **LIMIT TYPE**

**LIMU** Sets the upper limit value for a limit testing segment.

Syntax **LIMU** <value> [suffix]

Item	Description
value	Format dependent.
suffix	DB, MM, UM, NM, S, MS, US, NS, PS, FS

Equivalent softkey: **SYSTEM**, **UPPER LIMIT**

**Instrument Commands**

**LINM** Displays the linear magnitude format.

Syntax **LINM**

Equivalent softkey: **FORMAT**, **LIN MAG**

**LINT** Selects the line type of a trace for plotting.

Syntax **LINT{DATA|MEMO}<value>**

Item	Description
value	0 to 10.

Equivalent softkey: **COPY**, **LINE TYPE DATA** or **LINE TYPE MEMORY**

**LISV** Displays a tabular listing of all the position values and their current measured values.

Syntax **LISV**

Equivalent softkey: **COPY**, **LIST VALUES**

**LOAD** Load the file associated with position {1-5} from disk. Requires pass control. To load a file by title, use the **TITF{1-5}** to first put the file name into the position 1-5 desired, then **LOAD{1-5}**.

Syntax **LOAD{1|2|3|4|5}**

Equivalent softkey: **RECALL**, **LOAD FROM DISK**

**LOGM** Displays in log magnitude format.

Syntax **LOGM**

Equivalent softkey: **FORMAT**, **LOG MAG**

**LRN** Input a learn string, previously obtained by the OUTPLEAS command. This command is equivalent to the INPULEAS command.

Syntax `LRN{? | <value>}`

**MARK** Selects the active marker, and moves it to the specified position value.

Syntax `MARK{1|2|3|4}<value> [suffix]`

Item	Description
value	Domain dependent.
suffix	DB, MM, UM, NM, S, MS, US, NS, PS, FS

Equivalent softkey: `(MKR)`, `MARKER 1` to `MARKER 4`

**MARKBUCK** Moves the active marker to specified data point number.

Syntax `MARKBUCK{? | <value>}`

Item	Description
value	0 to 400.

**MARKCENT** Changes the stimulus center value to the active marker value.

Syntax `MARKCENT`

Equivalent softkey: `(MKR FCTN)`, `MARKER → CENTER`

**MARKFIXM** Puts a fixed reference marker at the present active marker position, and makes the fixed marker stimulus and response values at that position equal to zero. This command is identical to the **MARKZERO** command.

Syntax `MARKFIXM`

Equivalent softkey: `(MKR)` or `(MKR FCTN)`, `MARKER → FIXED MKR`

**MARKFPOS** Sets the fixed marker position value offset.

Syntax **MARKFPOS** <value> [suffix]

Item	Description
value	Domain dependent.
suffix	DB, MM, UM, NM, S, MS, US, NS, PS, FS

Equivalent softkey: **(MKR)**, **FIXED MKR POSITION**

**MARKFVAL** Sets the fixed marker position value offset.

Syntax **MARKFVAL** <value> [suffix]

Item	Description
value	Format dependent.
suffix	DB, MM, UM, NM, S, MS, US, NS, PS, FS

Equivalent softkey: **(MKR)**, **FIXED MKR VALUE**

**MARKMAXI** Moves the active marker to the maximum point on the trace. This command is identical to the **MAXS** command.

Syntax **MARKMAXI**

Equivalent softkey: **(MKR FCTN)**, **MAX SEARCH**

**MARKMIDD** Sets the middle value for the delta limit using the active marker value.

Syntax **MARKMIDD**

Equivalent softkey: **(SYSTEM)**, **MIDDLE VALUE**

**MARKOFF** Turns off all the markers and the delta reference marker.

Syntax **MARKOFF**

Equivalent softkey: **MKR**, **ALL MKR OFF**

**MARKP** Places the active marker on the next peak higher, left, lower or right of its current position.

Syntax **MARKP**{**HIG**|**LEF**|**LOW**|**RIG**}

Equivalent softkey: **MKR FCTN**, **NEXT PEAK HIGHER**, **NEXT PEAK LEFT**, **NEXT PEAK LOWER**, and **NEXT PEAK RIGHT**

**MARKPOSI** While editing a limit segment, sets the position value to the active marker value.

Syntax **MARKPOSI**

Equivalent softkey: **SYSTEM**, **MARKER -> POSITION**

**MARKPTRA** Places the active marker on the peak nearest its current position and while this function is on places the active marker at the nearest peak at the end of each sweep.

Syntax **MARKPTRA**{**ON**|**OFF**|**?**}

Equivalent softkey: **MKR FCTN**, **PEAK TRACK on OFF**

**MARKREF** Changes the reference value to the active marker's response value, without changing the reference position.

Syntax **MARKREF**

Equivalent softkey: **SCALE REF**, **MARKER → REFERENCE**

**MARKSPAN** Changes the start and stop values of the stimulus span to the active marker and the delta reference marker.

Syntax **MARKSPAN**

Equivalent softkey: **(MKR FCTN)**, **MARKER Δ → SPAN**

**MARKSTAR** Changes the stimulus start value to the active marker value.

Syntax **MARKSTAR**

Equivalent softkey: **(MKR FCTN)**, **MARKER → START**

**MARKSTOP** Changes the stimulus stop value to the active marker value.

Syntax **MARKSTOP**

Equivalent softkey: **(MKR FCTN)**, **MARKER → STOP**

**MARKZERO** Puts a fixed reference marker at the present active marker position, and makes the fixed marker stimulus and response values at that position equal to zero. This command is identical to the **MARKFIXM** command.

Syntax **MARKZERO**

Equivalent softkey: **(MKR)** or **(MKR FCTN)**, **MARKER → FIXED MKR**

**MARKZOOM** Sets active marker on nearest peak, moves marker (with peak) to center, and reduces span by one step (1, 2, 5).

Syntax **MARKZOOM**

Equivalent softkey: **(MKR FCNT)**

**MAXS** Moves the active marker to the maximum point on the trace. This command is identical to the **MARKMAXI** command.

Syntax **MAXS**

Equivalent softkey: **(MKR FCTN)**, **MAX SEARCH**

**MEAR** Aborts the sweep in progress, then restarts the measurement.

Syntax **MEAR** or **REST**

Equivalent softkey: **MEAS**, **MEASURE RESTART**

**MEASSTAN** Measures magnitude calibration standard.

Syntax **MEASSTAN**

Equivalent softkey: **CAL**, **MEASURE STANDARD**

**MEMO** Select Memory 1 or Memory 2 as the current memory.

Syntax **MEMO**{1|2}

Equivalent softkey: **DISPLAY**, **MEMORY 1** and **MEMORY 2**

**MENU** Specify display of the top level menu for each of the hard keys. Must be preceded by the **MENUON** command.

Syntax **MENU**{AVG|CAL|COPY|DISP|FORM|MARK|MEAS|MRKF|RECA|  
SAVE|SCAL|STIM|SYST}

**MENUON** Turns on the display of the current menu. Must precede the display of a particular menu.

Syntax **MENUON**

**MENUOFF** Turns off the display of the current menu.

Syntax **MENUOFF**

**NEXP** Displays the next page of information in a tabular listing onto the display.

Syntax **NEXP**

Equivalent softkey: **COPY**, **NEXT PAGE**

**NOOP** The “no operation” command.

Syntax **NOOP**

**NUMG** Triggers a user-specified number of sweeps, and returns to the hold mode.

Syntax **NUMG**{? | <value>}

Item	Description
value	1 to 999.
value	1.0000 to 200, default 1.0

**OPC** Operation complete. Reports the completion of the next command received by setting bit 0 in the event status register, or by replying to the interrogation form of the command OPC?.

Syntax **OPC**

**OPEP** Lists the key parameters on the display.

Syntax **OPEP**

Equivalent softkey: **COPY**, **OPERATING PARAMETERS**

**OUTPACTI** Outputs the active entry area function value, or the value of the last active function if the active entry area is off.

Syntax **OUTPACTI**

**OUTPDATA** Outputs the error corrected data Data format data, 0).

Syntax **OUTPDATA**

**OUTPERRO** Outputs the error message in the error queue Data format Error Number, “string” of no more than 50 characters).

Syntax **OUTPERRO**



**OUTPFORM** Outputs the formatted trace data. Format depends on the current setting for display format.

Syntax **OUTPFORM**

**OUTPIDEN** Outputs the identification string, **HEWLETT PACKARD , 8504A , 0 , X . XX**, where **X . XX** is the firmware revision. This command is identical to the **IDN?** command.

Syntax **OUTPIDEN**

**OUTPKEY** Outputs the key code of the last key pressed. An invalid key is outputted with **63**, a knob turn with **-1**.

Syntax **OUTPKEY**

Refer to the **KEY** command in this chapter for a figure that shows the key codes that correspond to front-panel keys.

**OUTPLEAS** Outputs the learn string, which contains the current instrument state of the reflectometer.

Syntax **OUTPLEAS**

**OUTPLIMF** Outputs the limit test results only for the failed points. Data format position, result (0 for fail, -1 for no test), upper limit, lower limit; Form 4)

Syntax **OUTPLIMF**

**OUTPLIML** Outputs the limit test results for each point. Data format position, result (1 for pass, 0 for fail, -1 for no test), upper limit, lower limit; This is always a Form 4, ASCII, transfer, regardless of the **FORM** command already set.)

Syntax **OUTPLIML**

**OUTPLIMM** Outputs the limit test result for the maker position. (Data format position, result (1 for pass, 0 for fail, -1 for no test), upper limit, lower limit)

Syntax **OUTPLIMM**

**OUTPMARK** Outputs the active marker values. Data format marker value, 0, position.  
Syntax **OUTPMARK**

**OUTPMEMO** Outputs the memory data. Data format data, 0.  
Syntax **OUTPMEMO**

**OUTPPLOT** Outputs the plot string. May be directed to a plotter or read into the computer.  
Syntax **OUTPPLOT**

**OUTPPRIN** Outputs the print string. May be directed to a printer or read into the computer.  
Syntax **OUTPPRIN**

**OUTPRAW1** Output the uncorrected data array. Data format data1, data2.  
Syntax **OUTPRAW1**

**OUTPTITL** Outputs the display title less than 54 characters.  
Syntax **OUTPTITL**

**PCB** Sets the HP-IB address which the reflectometer uses to communicate with an external controller. This address must match that set on the system controller's interface in order for **USEPASC** to function properly. The default value, 21, is set for the HP 9000 series 200/300 computers. This should be set to 30 when using the HP 82335A Interface Card. This command is identical to the **ADDRCONT** command.

Syntax **PCB**{?|<value>}

Item	Description
value	0 to 30, default 21.

Equivalent softkey: **LOCAL**, **ADDRESS CONTROLLER**

**P** Selects whether data, memory, the graticule, markers, and/or text is to be plotted when using the **PLOT** command.

Syntax **P**{**DATA**|**MEM**|**GRAT**|**MKR**|**TEXT**}-{**ON**|**OFF**|**?**}

Equivalent softkey: **COPY**, **DEFINE PLOT**

**PEAKEXCU** Sets the excursion value used to define a peak for the peak search functions.

Syntax **PEAKEXCU**{**?**|<value>}

Item	Description
value	0 to 100, default 6.

Equivalent softkey: **MKR FCTN**, **PEAK EXCURSION**

**PEAKTHRE** Sets the threshold value that a data point must be above to be defined as a peak during a peak search.

Syntax **PEAKTHRE**{**?**|<value>}

Item	Description
value	-100 to 0, default -70.

Equivalent softkey: **MKR FCNT**, **PEAK THRESHOLD**

**PENN** Selects the pen number for data, memory, the graticule, markers, or text when using the **PLOT** command.

Syntax **PENN**{**DATA**|**MEMO**|**GRAT**|**MARK**|**TEXT**}-{**?**|<value>}

Item	Description
value	0 to 10.

Equivalent softkey: **COPY**, **DEFINE PLOT**

**PLOS** Sets the plotting speed to fast or slow.

Syntax **PLOS**{**FAST**|**SLOW**}

Equivalent softkey: **(COPY)**, **PLOT SPEED**

**PLOT** Plots the display to a graphics plotter.

Syntax **PLOT**

Equivalent softkey: **(COPY)**, **PLOT**

**PREP** Displays the previous page of information in a tabular listing onto the display.

Syntax **PREP**

Equivalent softkey: **(COPY)**, **PREV PAGE**

**PRES** Sets the reflectometer to the factory preset condition.

Syntax **PRES**

Equivalent key **(PRESET)**

**PRINALL** Copies the measurement display to the printer.

Syntax **PRINALL**

Equivalent softkey: **(COPY)**, **PRINT**

**PRIC** Selects color printing.

Syntax **PRIC**

Equivalent softkey: **(COPY)**, **COLOR**

**PRIS** Sets the print command to the default selection.

Syntax **PRIS**

Equivalent softkey: **COPY**, **PRINT STANDARD**

**PURG** Removes the file associated with position {1-5} from disk. Requires pass control. To remove a file by title, use the **TITF**{1-5} first to put the file name into the position 1-5 desired, then **PURG**{1-5}.

Syntax **PURG**{1|2|3|4|5}

Equivalent softkey: **SAVE**, **STORE TO DISK**

**RECA** Recall internal register 1, 2, 3, 4, or 5.

Syntax **RECA**{1|2|3|4|5}

**RECO** Recalls the previously saved color set.

Syntax **RECO**

Equivalent softkey: **DISPLAY**, **RECALL COLORS**

**REFP** Sets the position of the reference line on the graticule of a Cartesian format.

Syntax **REFP**{?|<value>}

Item	Description
value	0 to 10 div.

Equivalent softkey: **SCALE REF**, **REFERENCE POSITION**

**REFT** Recall file titles from disk. Requires pass control.

Syntax **REFT**

Equivalent softkey: **RECALL**, **READ FILE TITLES**

**REFV** Changes the value of the reference line, moving the measurement trace correspondingly.

Syntax **REFV** <value> [suffix]

Item	Description
value	Format dependent.
suffix	DB, MM, UM, NM, S, MS, US, NS, PS, FS

Equivalent softkey: **SCALE REF**, **REFERENCE VALUE**

**RESD** Turns off a tabular listing (**OPEP** or **LISV**) and returns the measurement display to the screen.

Syntax **RESD**

Equivalent softkey: **COPY**, **RESTORE DISPLAY**

**REST** Aborts the sweep in progress, then restarts the measurement.

Syntax **REST**

Equivalent softkey: **MEAS**, **MEASURE RESTART**

**RIGL** Draws a quarter-page plot in the lower right quadrant of the page.

Syntax **RIGL**

Equivalent softkey: **COPY**, **RIGHT LOWER**

**RIGU** Draws a quarter-page plot in the upper right quadrant of the page.

Syntax **RIGU**

Equivalent softkey: **COPY**, **RIGHT UPPER**

**RSCO** Resets the modified colors to the default colors.

Syntax **RSCO**

Equivalent softkey: **DISPLAY**, **RESET COLOR**

**SADD** Adds a new segment to the limit line table.

Syntax **SADD**

Equivalent softkey: **SYSTEM**, **ADD**

**SAVUASCI** Stores appropriate files to disk as ASCII files CITIFile. Only specific data files are formatted as (CITIFile); the instrument state file, and others are always stored as binary.

Syntax **SAVUASCI**

Equivalent softkey: **SAVE**, **STORE TO DISK**, **DEFINE STORE**, **DISK FILE FORMAT**

**SAVUBINA** Stores appropriate files to disk as binary files.

Syntax **SAVUBINA**

Equivalent softkey: **SAVE**, **STORE TO DISK**, **DEFINE STORE**, **DISK FILE FORMAT**

**SAVE** Save the current instrument state in internal register 1, 2, 3, 4, or 5.

Syntax **SAVE**{1|2|3|4|5}

**SCAL** Changes the response value scale per division of the graticule.

Syntax **SCAL** <value> [suffix]

Item	Description
value	Format dependent.
suffix	DB, MM, UM, NM, S, MS, US, NS, PS, FS

**Instrument Commands**

Equivalent softkey: **SCALE REF**, **SCALE/DIV**

**SCAP** Selects the normal full size scale for plotting, or a plot where the graticule is expanded to P1 and P2 of the plotter.

Syntax **SCAP**{**FULL** | **GRAT**}

Equivalent softkey: **COPY**, **SCALE PLOT**

**SDEL** Deletes a segment from the limit line table.

Syntax **SDEL**

Equivalent softkey: **SYSTEM**, **DELETE**

**SDON** Completes editing the limit table.

Syntax **SDON**

Equivalent softkey: **SYSTEM**, **DONE**

**SEDI** Determines a segment of the limit line table.

Syntax **SEDI**{? | <value>}

Item	Description
value	Depends on table type.

Equivalent softkey: **SYSTEM**, **SEGMENT**, **EDIT**

**SING** Makes a single measurement sweep, then sets the hold mode.

Syntax **SING**

Equivalent softkey: **MEAS**, **SINGLE**



**SOFR** Display the firmware revision in the active entry area.

Syntax **SOFR**

Equivalent softkey: **SYSTEM**, **SERVICE MENU**

**SOUR1300** Select 1300 nm source.

Syntax **SOUR1300**

Equivalent softkey: **MENU**, **1300 nm**

**SOUR1550** Select 1550 nm source.

Syntax **SOUR1550**

Equivalent softkey: **MENU**, **1550 nm**

**SOUREXT** Select external source and set wavelength.

Syntax **SOUREXT**{? | <value>}

Item	Description
value	1200 to 1600.

Equivalent softkey: **MENU**, **EXTERNAL**

**SOUROFF** Turn off internal sources.

Syntax **SOUROFF**

Equivalent softkey: **SOURCE OFF**

**SPAN** Sets the stimulus span.

Syntax **SPAN** <value> [suffix]

Item	Description
value	Domain dependent.
suffix	DB, MM, UM, NM, S, MS, US, NS, PS, FS

**Instrument Commands**

Equivalent softkey: **MENU**, **SPAN**

**SRE** Service request enable. The value is the mask which enables specific bits in the status byte for generating an SRQ.

Syntax **SRE**{?|<value>}

**STAR** Defines the start stimulus value..

Syntax **STAR** <value> [suffix]

Item	Description
<b>value</b>	Domain dependent.
<b>suffix</b>	DB, MM, UM, NM, S, MS, US, NS, PS, FS

Equivalent softkey: **MENU**, **START**

**STB?** Reads the status byte.

Syntax **STB?**

**STOP** Defines the stop value of the stimulus..

Syntax **STOP** <value> [suffix]

Item	Description
<b>value</b>	Domain dependent.
<b>suffix</b>	DB, MM, UM, NM, S, MS, US, NS, PS, FS

Equivalent softkey: **MENU**, **STOP**

**STOR** Store the file associated with position 1, 2, 3, 4, or 5 to disk. Requires pass control. To store a file by title, use **TITF** first to put the file name into the position 1 through 5 as desired, then use **STOR**.

Syntax **STOR**{1|2|3|4|5}

Equivalent softkey: **SAVE**, **STORE TO DISK**

**SVCO** Saves the modified color set.

Syntax **SVCO**

Equivalent softkey: **DISPLAY**, **SAVE COLORS**

**TALKLIST** Puts the reflectometer in talker/listener HP-IB mode.

Syntax **TALKLIST**

Equivalent softkey: **LOCAL**, **TALKER/LISTER**

**TIME** Formats the horizontal axis as time.

Syntax **TIME**

Equivalent softkey: **FORMAT**, **IME**

**TINT** Adjusts the hue of the chosen attribute. Refer to the **COLO** command.

Syntax **TINT**{?|<value>}

Item	Description
value	0 to 100.

Equivalent softkey: **DISPLAY**, **TINT**

**TITF** Title the file associated with position 1 through 5 for subsequent disk access. Used in conjunction with **LOAD**, **STORE**, and **PURG** to put a file name into the position 1 through 5 as desired.

Syntax **TITF**{1|2|3|4|5} <string>

Item	Description
string	Up to 8 alphanumeric characters, first character must be alphabetic.

Equivalent softkey: **SAVE**, **TITLE FILES**

**TITL** Sends the string to the title area on the display.

Syntax **TITL** <string>

Item	Description
string	Up to 53 characters.

Equivalent softkey: **DISPLAY**, **TITLE**

**TITR** Title the internal register associated with position 1, 2, 3, 4, or 5. Used in conjunction with **SAVE** and **RECA**.

Syntax **TITR**{1|2|3|4|5} <string>

Item	Description
string	Up to 8 alphanumeric characters, first character must be alphabetic.

Equivalent softkey: **SAVE**, **TITLE REGISTER**

**TRIG** HP-IB trigger. Puts reflectometer into hold.

Syntax **TRIG**

**UP** Increments the value in the active entry area. This command is identical to pressing the up-arrow key.

Syntax **UP**

**USEPASC** Puts the reflectometer in use pass control HP-IB mode.

Syntax **USEPASC**

Equivalent softkey: **LOCAL**, **USE PASS CONTROL**

**WAIT** Wait for a clean sweep.

Syntax **WAIT**

**ZERS** Enables or disables zero span mode of operation.

Syntax **ZERS**{**ON**|**OFF**|**?**}

Equivalent softkey: **MENU**, **ZERO SPAN on OFF**

## Keys versus Commands

### Keys versus Commands

Key	Equivalent Programming Command
<b>↑</b>	UP
<b>↓</b>	DOWN
<b>Δ</b> MODE OFF	DELO
<b>Δ</b> REF=1 to <b>Δ</b> REF=4	DELR
<b>Δ</b> REF= <b>Δ</b> FIXED MKR	DELRFXM
1300 nm	SOUR1300
1550 nm	SOUR1550
ADD	SADD
ADDRESS CONTROLLER	ADDRCONT
ADDRESS DISK	ADDRDISK
ADDRESS PLOTTER	ADDRPLOT
ADDRESS PRINTER	ADDRPRIN
all OFF	MARKOFF
AMPLITUDE OFFSET	LIMIAMPO
ASCII	SAVUASCI
AUTO SCALE	AUTO
AVERAGING FACTOR	AVERFACT
AVERAGING on OFF	AVERO
AVERAGING RESTART	AVERREST
BACKGROUND INTENSITY	BACI
BALANCE RECEIVER	BALR
BEEP DONE ON off	BEEPDONE
BEEP FAIL on off	BEEPFAIL
BEEP WARN on OFF	BEEPWARN
BRIGHTNESS	CBRI
CALIBRATE MAGNITUDE	CALM
<b>CENTER</b>	CENT
CH1 DATA LIMIT LN	COLODATA
CLEAR ALL	CLEARALL

**Keys versus Commands (continued)**

<b>Key</b>	<b>Equivalent Programming Command</b>
CLEAR REG1 to REG5	CLEA
COLOR	COLOR, PRIC
CONTINUOUS	CONT
COPY FROM FILE TITLE	COPYFRFT
COPY FROM REG TITLES	COPYFRRT
CORRECTION on OFF	CORR
DATA → MEMORY	DATI
DATA and MEMORY	DISPDATM
DATA ARRAY on OFF	EXTMDATA
DEFAULT COLORS	DEFC
DELETE	SDEL
DELTA LIMITS	LIMD
DISK UNIT NUMBER	DISKUNIT
DISP MKRS ON off	DISM
DISPER COR ON off	DISPCOR
DISPLAY DATA	DISPDATA
DONE	BALD, EDITDONE
EDIT	SEDI
EDIT LIMIT LINE	EDITLIML
EXIT	BALE, CALE
EXT. TRIG on OFF	EXTT
EXTERNAL	SOUREXT
FIXED MKR	MARKFVAL
FIXED MKR POSITION	MARKFPOS
FLAT LINE	LIMTFL
FORMAT ARRAY on OFF	EXTMFORM
FORMAT BINARY	SAVUBINA
FRESNEL	CALSFRES
FULL PAGE	FULP
FULL SPAN	FULS
GRAPHICS ARRAY on OFF	EXTMGRAP
GRATICULE TEXT	COLOGRAT

**Keys versus Commands****Keys versus Commands (continued)**

<b>Key</b>	<b>Equivalent Programming Command</b>
GROUP INDEX  n	GROI
GUIDED CAL	GUIC
GUIDED SETUP	GUIS
HORIZ DISTANCE	DIST
HP-IB DIAG on OFF	DEBU
INITIALIZE DISK	INID
INTENSITY	INTE
LEFT LOWER	LEFL
LEFT UPPER	LEFU
LIMIT LINE on off	LIMILINE
LIMIT TEST on off	LIMITEST
LIN MAG	LINM
LINE TYPE DATA	LINTDATA
LINE TYPE MEMORY	LINTMEMO
LISTS	LISV
LOAD FILE1 to FILE5	LOAD
LOWER LIMIT	LIML
MARKER → AMP. OFS	LIMIMAOF
MARKER → CENTER	MARKCENT
MARKER → FIXED MKR	MARKFIXM
MARKER → FIXED MKR	MARKFIXM
MARKER → MIDDLE	MARKMIDD
MARKER → POSITION	MARKPOSI
MARKER → REFERENCE	MARKREF
MARKER → START	MARKSTAR
MARKER → STOP	MARKSTOP
MARKER 1 to 4	MARK
MARKER Δ → SPAN	MARKSPAN
MAX SEARCH	MAXS
MAX SEARCH	MAXS
MEASURE RESTART	REST
MEASURE STANDARD	MEASSTAN



**Keys versus Commands (continued)**

<b>Key</b>	<b>Equivalent Programming Command</b>
MEMORY	DISPMEMO
MEMORY 1	MEMO1
MEMORY 1	COLOMEM1
MEMORY 2	MEMO2
MEMORY2 REF LINE	COLOMEM2
MIDDLE	LIMM
MKR ZOOM	MARKZOOM
NEXT PAGE	NEXP
NEXT PEAK HIGHER	MARKPHIG
NEXT PEAK LEFT	MARKPLEF
NEXT PEAK LOWER	MARKPLOW
NEXT PEAK RIGHT	MARKPRIG
OPERATING PARAMETERS	OPEP
PEAK EXCURSION	PEAKEXCU
PEAK THRESHOLD	PEAKTHRE
PEAK TRACK on OFF	MARKPTRA
PEN NUM DATA	PENNDAT
PEN NUM GRATICULE	PENNGRAT, DFLT
PEN NUM MARKER	PENMARK
PEN NUM MEMORY	PENMEMO
PEN NUM TEXT	PENNTXT
PLOT	PLOT
PLOT DATA ON off	PDATA
PLOT GRAT ON off	PGRAT
PLOT MEM ON off	PMEM
PLOT MKR ON off	PMKR
PLOT SPEED [FAST]	PLOFAST
PLOT SPEED [SLOW]	PLOSSLOW
PLOT TEXT ON off	PTEXT
POSITION	LIMP
POSITION OFFSET	LIMIPOSO
<b>PRESET</b>	PRES, RST*

**Keys versus Commands****Keys versus Commands (continued)**

<b>Key</b>	<b>Equivalent Programming Command</b>
PREV PAGE	PREP
PRINT	PRINALL
PRINT STANDARD	PRIS
PURGE FILE1 to FILE5	PURG
RAW ARRAY on OFF	EXTMRAW
READ FILE TITLES	REFT
RECALL COLORS	RECO
RECALL REG1 to REG5 (PRESET5)	RECA
REFERENCE	REFV
REFERENCE POSITION	REFP
RESET COLOR	RSCO
RESTORE DISPLAY	RESD
RIGHT LOWER	RIGL
RIGHT UPPER	RIGU
SAVE COLORS	SVCO
SAVE REG1 to REG5 (PRESET5)	SAVE
SCALE I/DIV	SCAL
SCALE PLOT [FULL]	SCAPFULL
SCALE PLOT [GRAT]	SCAPGRAT
SINGLE	SING
SINGLE POINT	LIMTSP
SLOPING LINE	LIMITSL
SOURCE OFF	SOUROFF
<b>(SPAN)</b>	SPAN
<b>(START)</b>	STAR
<b>(STOP)</b>	STOP
STOR FILE1 to FILE5	STOR
TALKER/LISTENER	TALKLIST
TEXT	COLOTEXT
TIME	TIME
TINT	TINT

**Keys versus Commands (continued)**

<b>Key</b>	<b>Equivalent Programming Command</b>
TITLE	TITL
TITLE FILE1 to FILE5	TITF
TITLE REG1 to REG5	TITR
TRIGGER HOLD	HOLD
UPPER LIMIT	LIMU
USE PASS CONTROL	USEPASC
USER STD	CALSUSER
VERT LOG MAG	LOGM
VOLUME NUMBER	DISKVOLU
WARNING	COLOWARN
ZERO SPAN on OFF	ZERS



**————** Reference

---

# Reference

## Contents

Menu Maps .....	5-3
Keys, Softkeys, and Connectors .....	5-11
Block Diagram .....	5-53
Front-Panel Fiber-Optic Adapters .....	5-54
Part Numbers .....	5-55
Instrument Options .....	5-56
Line-power Cables .....	5-57

# Menu Maps

The menu maps in this section graphically represent the softkey menus that are displayed on the screen.

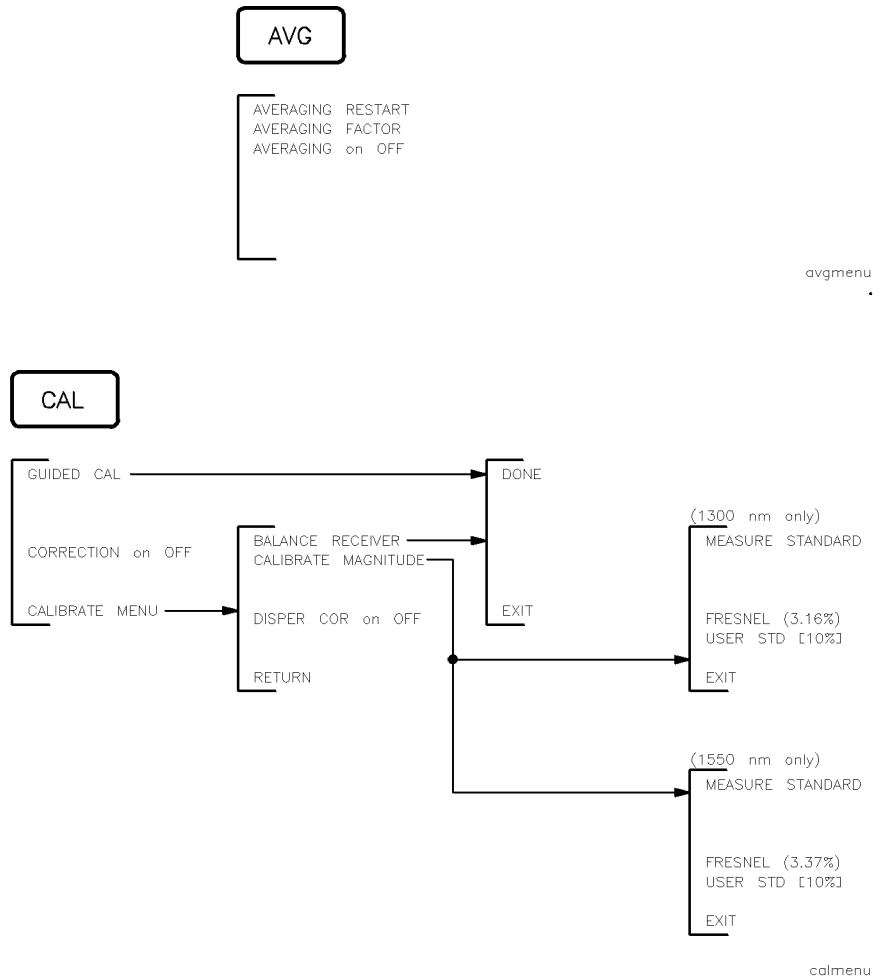

Reference  
**Menu Maps**

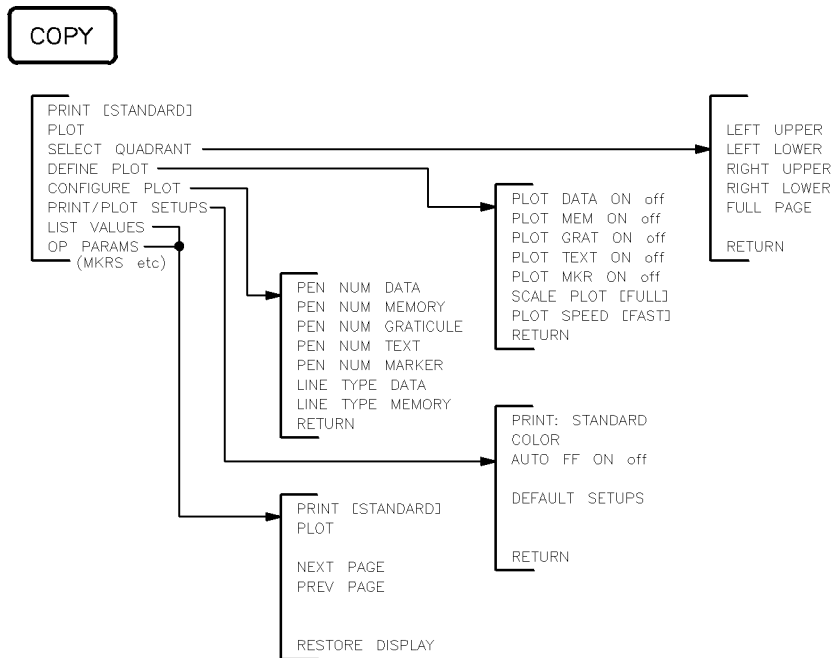

copymenu



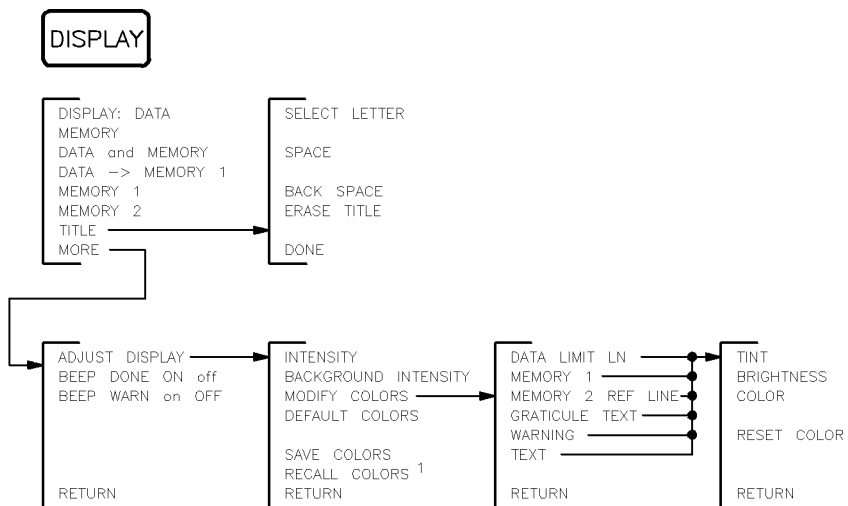

1. Displayed only if color was previously saved.

displaym

## FORMAT

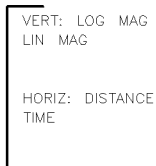

formatm

**Menu Maps**

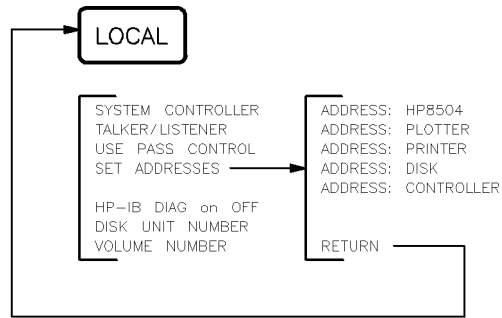

localm

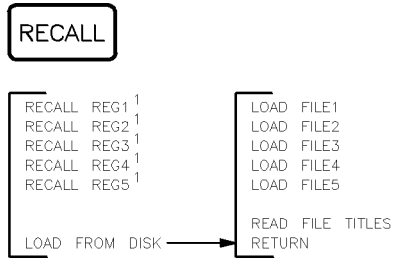

1. This softkey appears only when information is saved to the register.

recallm

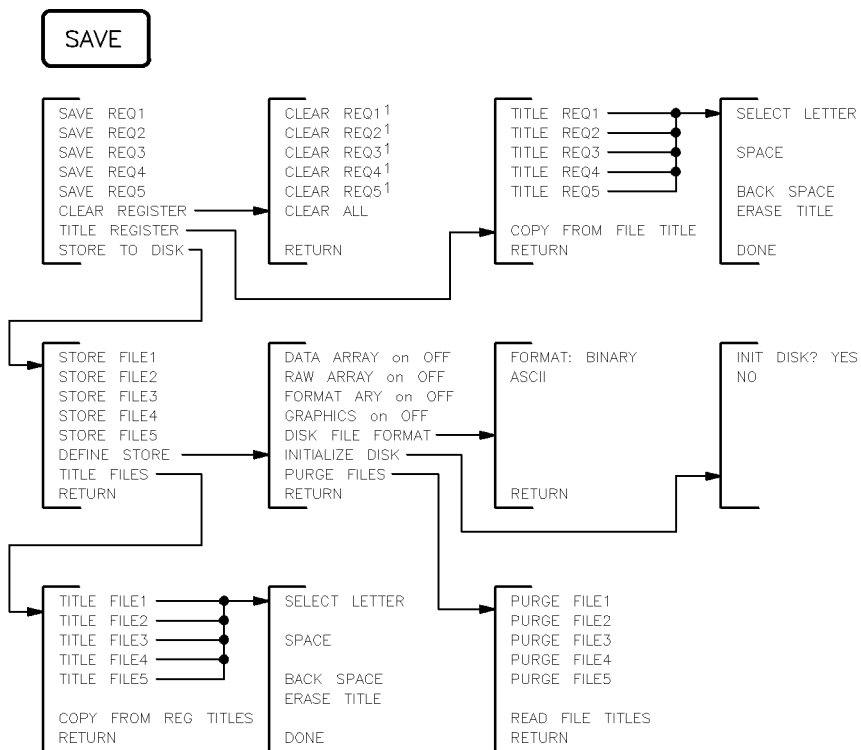

1. This softkey appears only when information is saved to the register.

savemenu

**Menu Maps**

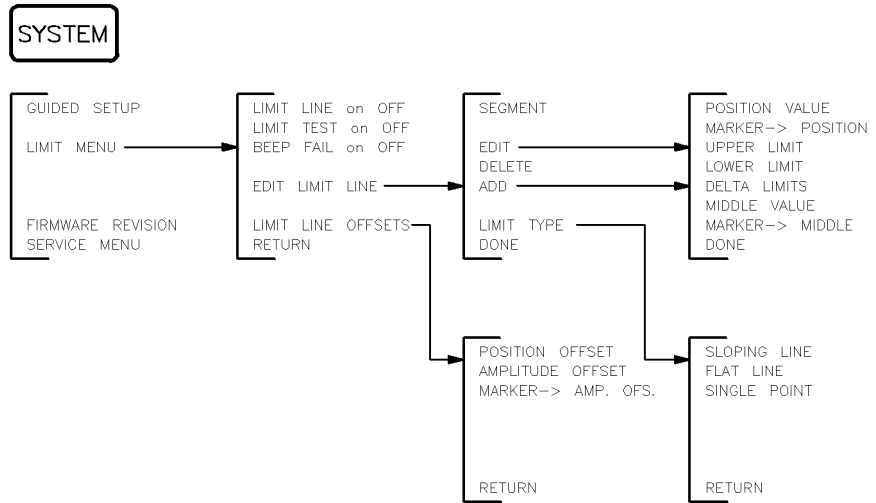

systemm

**MEAS**

MEASURE RESTART  
 REFRACTIVE INDEX (n)  
 TRIGGER: HOLD  
 SINGLE  
 CONTINUOUS  
 EXT TRIG on OFF

measmenu

### MENU

```

FULL SPAM
ZERO SPAN on OFF

SOURCE: OFF
1300 nm
1550 nm
EXTERNAL
    
```

menumenu

### MKR

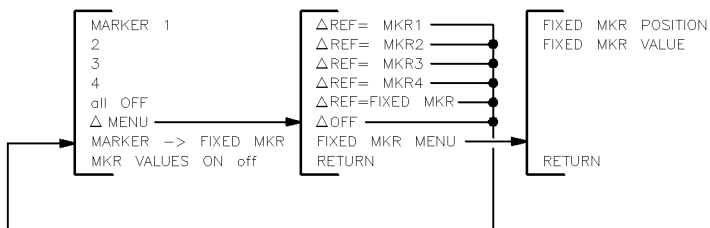

mkrmenu

### MKR FCTN

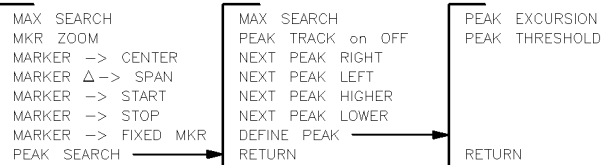

mkrfctnm

**PRESET**

GUIDED SETUP

presetm

**SCALE  
REF**

AUTO SCALE  
SCALE (/div)

REFERENCE POSITION  
REFERENCE VALUE

MARKER -> REFERENCE

scalem

## Keys, Softkeys, and Connectors

This section is a dictionary reference of front and rear-panel connectors, front-panel keys, and softkeys. Keys that begin with a symbol are listed at the front of the section.

**\* status notation** Indicates measurement parameters changed. Measured data is in doubt until a complete clean sweep has been taken.

**Δ MENU** Activates the delta marker menu. This menu is used to designate a reference marker and read the difference in values between it and the active marker.

Key Path: **(MKR)**, **Δ MENU**

**Δ OFF** Turns off the delta marker mode so that the displayed marker annotation shows absolute values.

Key Path: **(MKR)**, **Δ MENU**, **Δ OFF**

**ΔREF= FIXED MKR** Establishes the fixed marker as the reference for delta markers. This softkey is identical to the **MARKER →FIXED MKR** softkey.

Key Path: **(MKR)**, **Δ MENU**, **ΔREF=FIXED MKR**

**ΔREF= MKR n** Establishes the selected marker as the delta reference. The active marker distance (or time) and amplitude values are then shown relative to this reference. The annotation **ΔREF=** is added to the softkey label.

Key Path: **(MKR)**, **Δ MENU**, **ΔREF=MKR n**

**Keys, Softkeys, and Connectors**

**1300 nm** Selects the internal 1300 nm source.

Key Path: **MENU**, **1300 nm**

**1550 nm** Selects the internal 1550 nm source.

Key Path: **MENU**, **1550 nm**

**ADD** Displays a menu that is used for adding new segments to the end of a limit-line table. The new segment is initially a duplicate of the segment indicated by the pointer >. If the table is empty, a default segment is displayed.

Key Path: **SYSTEM**, **LIMIT MENU**, **EDIT LIMIT LINE**, **ADD**

**ADDRESS:** Enters the HP-IB address that the precision reflectometer uses to communicate with an external controller.  
**CONTROLLER**

Key Path: **LOCAL**, **SET ADDRESSES**, **ADDRESS: CONTROLLER**

**ADDRESS:** Enters the HP-IB address that the precision reflectometer uses to communicate with an external disk drive.  
**DISK**

Key Path: **LOCAL**, **SET ADDRESSES**, **ADDRESS: DISK**

**ADDRESS:** Enters the HP-IB address of the precision reflectometer. There is no physical address switch.  
**HP8504**

Key Path: **LOCAL**, **SET ADDRESSES**, **ADDRESS: HP8504**

**ADDRESS:** Enters the HP-IB address that the precision reflectometer uses to communicate with a plotter.  
**PLOTTER**

Key Path: **LOCAL**, **SET ADDRESSES**, **ADDRESS: PLOTTER**



**ADDRESS:** Enters the HP-IB address that the precision reflectometer uses to communicate with a printer.

**PRINTER**

Key Path: **LOCAL**, **SET ADDRESSES**, **ADDRESS: PRINTER**

**ADJUST** Accesses a menu that allows you to change the colors and intensity of the display.

**DISPLAY**

Key Path: **DISPLAY**, **MORE**, **ADJUST DISPLAY**

**all** Turns off all the markers, including the delta reference marker and the fixed marker. This softkey also turns off peak tracking.

**OFF**

Key Path: **MKR**, **all OFF**

**AMPLITUDE** Moves limit lines vertically by adding or subtracting an offset in amplitude value. This allows limit lines already defined to be used for testing at a different response level. For example, if attenuation is added to or removed from a test setup, the limit lines can be offset an equal amount.

**OFFSET**

Key Path: **SYSTEM**, **LIMIT MENU**, **LIMIT LINE OFFSETS**,  
**AMPLITUDE OFFSET**

**ASCII** Selects an ASCII data format known as CITIfile (common instrumentation transfer and interchange file). This ASCII data format is useful when data will be exchanged with a compatible computer. The learn string and user graphics display data are always stored in binary format because they are useful only to the reflectometer. They should not be modified with an external computer. The following data is formatted. Each array is stored separately:

- Data arrays (corrected)
- Raw data arrays
- Formatted array
- Display memory array

Key Path: **SAVE**, **STORE TO DISK**, **DEFINE STORE**, **DISK FILE FORMAT**,  
**ASCII**

**Keys, Softkeys, and Connectors**

**AUTO FF** Causes an external printer to automatically form feed to the next page after printing one page of information.

Key Path: **COPY**, **PRINT/PLOT SETUPS** **AUTO FF ON off**

**AUTO SCALE** Sets the scale and reference values to display all of the trace data as large as possible on the screen without cutting off any of it.

Key Path: **SCALE REF**, **AUTO SCALE**

**AUX INPUT connector** This rear-panel connection is used to connect DC or AC voltages from the lightwave section to the display processor section for display and measurement processing.

**AVG** Displays a menu of functions that are used to reduce any displayed noise.

**Avg status notation** Indicates that sweep-to-sweep averaging is on. The averaging count is shown immediately below this notation.

**AVERAGING FACTOR** Sets the number of traces that are averaged together. The range is from 1 to 999.

Key Path: **AVG**, **AVERAGING FACTOR**

**AVERAGING on OFF** Reduces displayed noise by averaging consecutive traces. When on, **Avg** is displayed above the count on the display's left side.

Key Path: **AVG**, **AVERAGING on OFF**

**AVERAGING RESTART** Restarts trace averaging when **AVERAGING on OFF** is set to **on**.

Key Path: **AVG**, **AVERAGING RESTART**

- BACKGROUND INTENSITY** Adjusts the intensity of the screen's background from 0% (black) to 100% (white). This intensity adjustment is not affected by preset or the **MODIFY COLORS**, **DEFAULT COLORS**, **SAVE COLORS**, or **RECALL COLORS**.  
Key Path: **DISPLAY**, **MORE**, **ADJUST DISPLAY**, **BACKGROUND INTENSITY**
- BACK SPACE** Deletes the last character entered when creating a title.  
Key Path: **DISPLAY**, **TITLE**, **BACK SPACE**  
Key Path: **SAVE**, **TITLE REGISTER**, **TITLE REGn**, **BACK SPACE**  
Key Path: **SAVE**, **STORE TO DISK**, **TITLE FILES**, **TITLE FILEn**, **BACK SPACE**
- BALANCE RECEIVER** Performs a balance receiver calibration. This ensures that the displayed response magnitude is insensitive to the polarization transformations of the fiber in the **TEST PORT** path when the return loss of the device being tested is polarization-independent.  
Key Path: **CAL**, **CALIBRATE MENU**, **BALANCE RECEIVER**
- BEEP DONE ON off** Causes the instrument to sound a beep upon completion of operations such as saving data into memory or saving an instrument state.  
Key Path: **DISPLAY**, **MORE**, **BEEP DONE ON off**
- BEEP FAIL on OFF** Turns the limit-line fail beeper on or off. When limit line testing is on, a beep is sounded each time a failure is detected. The limit fail beeper is independent of the warning beeper and the operation complete beeper.  
Key Path: **SYSTEM**, **LIMIT MENU**, **BEEP FAIL on OFF**

**Keys, Softkeys, and Connectors**

**BEEP WARN** Causes a beep sound whenever a cautionary message is displayed.

**on OFF** Key Path: **DISPLAY**, **MORE**, **BEEP WARN on OFF**

**BLUE connector** This rear-panel connector is one of three outputs (RED, GREEN, BLUE) that drive an external monitor. The monitor must have the following characteristics:

- RGB with synch on green
- 75 $\Omega$  impedance
- 1V p-p (0.7V = white; 0V = black; -0.3V = synch)

**BRIGHTNESS** Adjusts the brightness of the selected screen color. Valid entries range from 0% (minimum) to 100%.

Key Path: **DISPLAY**, **MORE**, **ADJUST DISPLAY**, **MODIFY COLORS**, **DATA LIMIT LN**, **BRIGHTNESS**

**C status notation** Indicates error correction (measurement calibration) is on.

**CAL** Presents a menu for performing measurement calibrations. Manual calibrations are faster than following the guided setup procedure.

**CALIBRATE MAGNITUDE** Starts a magnitude calibration. Always perform a balance receiver calibration before a magnitude calibration.

Key Path: **CAL**, **CALIBRATE MENU**, **CALIBRATE MAGNITUDE**

**CALIBRATE MENU** Displays a menu for performing manual calibrations.

Key Path: **CAL**, **CALIBRATE MENU**

- CENTER** Sets the center value of the screen's horizontal scale. The default setting is 200 mm. The time scale equivalent is 700 ps.
- CLEAR ALL** Clears all instrument-state registers.  
Key Path: **SAVE**, **CLEAR REGISTER**, **CLEAR ALL**
- CLEAR REGn** Clears the specified instrument-state register 1, 2, 3, 4, or 5.  
Key Path: **SAVE**, **CLEAR REGISTER**, **CLEAR REGn**
- CLEAR REGISTER** Presents a menu that is used to clear instrument-state registers.  
Key Path: **SAVE**, **CLEAR REGISTER**
- COLOR** In the **COPY** menus, this softkey specifies a color printer. In the **DISPLAY** menus, this softkey changes the color of the selected element. Values ranges from 0% (no color, all white) to 100% (all color, no white). For example, when the tint is red, increasing the color changes it from white (no color), to pink, light red, red, brilliant red.  
Key Path: **DISPLAY**, **MORE**, **ADJUST DISPLAY**, **MODIFY COLORS**, **DATA LIMIT LN**, **COLOR**  
Key Path: **COPY**, **PRINT/PLOT SETUPS**, **COLOR**
- CONFIGURE PLOT** Displays a menu from which you can select plotter pens for drawing specific display items.  
Key Path: **COPY**, **CONFIGURE PLOT**
- CONTINUOUS** This is the standard sweep state. The sweep is triggered automatically and continuously and the trace is updated with each sweep.  
Key Path: **MEAS**, **CONTINUOUS**

**COPY** Presents a menu for printing and plotting the display.

**COPY FROM FILE TITLE** Renames the instrument-state registers to match the current names of the store files. For example, the default names of the instrument-state registers are REG1 through REG5. The default names of the store files are FILE1 through FILE5. Pressing this key would rename the instrument-state registers FILE1 through FILE5. If you have modified the names of the store files, the modified names are copied to the instrument-state save register names.

Key Path: **SAVE**, **TITLE REGISTER**, **COPY FROM FILE TITLE**

Key Path: **SAVE**, **STORE TO DISK**, **TITLE FILES**,  
**COPY FROM FILE TITLE**

**COPY FROM REG TITLES** Renames the store files to match the current names of the instrument-state registers. It does not change the names of any files already stored to disk. For example, the default names of the instrument-state registers are REG1 through REG5. The default file names of the store files are FILE1 through FILE5. Pressing this key would rename the store files REG1 through REG5. If the names of the instrument-state save registers have been modified, the modified names are copied to the store file names.

Key Path: **COPY FROM REG TITLES**

**CORRECTION on OFF** Turns on or off the application of balance receiver and magnitude calibration data. When off, default values are used. The precision reflectometer turns correction on automatically after a calibration. If the instrument is not calibrated, and you attempt to turn correction on, the error message **CAUTION: CALIBRATION REQUIRED** appears on the display.

Turning correction off does not destroy the calibration data; the calibration data is recovered when correction is turned back on.

Key Path: **CAL**, **CORRECTION on OFF**

- D status notation** Indicates chromatic dispersion correction is on. This notation is available for the 1550 nm source only. Refer to “Performing Manual Calibrations” in Chapter 2 for more information.
- DATA → MEMORY 1** Stores the current trace data in the volatile memory unless the \* status notation is displayed at the screen’s left side. When memory 2 is active, the key reads **DATA → MEMORY 2**. (\* indicates that the instrument has not completed a sweep after a parameter change.)  
Key Path: **DISPLAY**, **DATA → MEMORY 1**
- DATA and MEMORY** Two temporary trace memories are available: *memory 1* and *memory 2*. If a trace has been stored in memory 1 or 2 this softkey displays two traces: the current trace and the selected memory. Use **MEMORY 1** and **MEMORY 2** to select the second displayed trace.  
Key Path: **DISPLAY**, **DATA and MEMORY**
- DATA ARRAY on OFF** Specifies whether or not to store error-corrected (calibration) data on the disk with the instrument state.  
Key Path: **SAVE**, **STORE TO DISK**, **DEFINE STORE**, **DATA ARRAY on OFF**
- DATA LIMIT LN** Presents softkeys for changing the tint, brightness, and color of the data trace and limit lines.  
Key Path: **DISPLAY**, **MORE**, **ADJUST DISPLAY**, **MODIFY COLORS**, **DATA LIMIT LN**
- DEFAULT COLORS** Returns all screen elements to their default factory-set colors.  
Key Path: **DISPLAY**, **MORE**, **ADJUST DISPLAY**, **DEFAULT COLORS**

**Keys, Softkeys, and Connectors**

**DEFAULT SETUPS** Resets the plotting parameters to their default values as shown in the following table. Default setups do not apply to prints. A beep sounds when default setups is selected.

**Default Plot Values**

Parameter	Default Setting
Select quadrant	full page
Define plot	all plot elements on
Plot scale	full
Plot speed	fast
Line type	7  solid line
Pen numbers	default values

Key Path: **COPY**, **PRINT/PLOT SETUPS**, **DEFAULT SETUPS**

**DEFINE PEAK** Presents a menu for defining the peak excursion and peak threshold values that are used to locate peak responses.

Key Path: **MKR FCTN**, **PEAK SEARCH**, **DEFINE PEAK**

**DEFINE PLOT** Presents a menu for selecting displayed items to plot on the plotter and for scaling the plot.

Key Path: **COPY**, **DEFINE PLOT**

**DEFINE STORE** Presents a menu that is used to specify what data is to be stored on disk in addition to the instrument state.

Key Path: **SAVE**, **STORE TO DISK**, **DEFINE STORE**

**DELETE** Deletes the limit-line segment indicated by the pointer >.

Key Path: **SYSTEM**, **LIMIT MENU**, **EDIT LIMIT LINE**, **DELETE**



**DELTA LIMITS** Sets the limits an equal amount above and below a specified middle value, instead of setting upper and lower limits separately. This is used in conjunction with **MIDDLE VALUE** or **MARKER →MIDDLE**, to set limits for testing a device that is specified at a particular value plus or minus an equal tolerance.

For example, a device may be specified at 0 dB ±3 dB. Enter the middle value as 0 dB and the delta limits as 3 dB. When **DELTA LIMITS** or **MIDDLE VALUE** is pressed, all the segments in the table are displayed in these terms, even if they were defined as upper and lower limits.

Key Path: **(SYSTEM)**, **LIMIT MENU**, **EDIT LIMIT LINE**, **EDIT**, **DELTA LIMITS**

**DISK FILE FORMAT** Presents a menu for selecting the format of data that will be saved on a disk.  
Key Path: **(SAVE)**, **STORE TO DISK**, **DEFINE STORE**, **DISK FILE FORMAT**

**DISK UNIT NUMBER** Specifies the number of the disk drive's disk that is to be accessed in an external disk store or load routine. This number is used with the disk drive's HP-IB address and volume number of the to gain access to a specific area on a disk. The access hierarchy is:

1. HP-IB address
2. Disk unit number
3. Disk volume number

Key Path: **(LOCAL)**, **DISK UNIT NUMBER**

**DISPER COR on OFF** Enables or disables the application of chromatic dispersion correction data taken using the 1550 nm source. This function has no effect upon the 1300 nm source. Refer to "Performing Manual Calibrations" in Chapter 2 for a discussion of chromatic dispersion effects.

Key Path: **(CAL)**, **CALIBRATE MENU**, **DISPER COR on OFF**

**Keys, Softkeys, and Connectors**

**DISPLAY** Provides functions for selecting the type of data displayed and how that data is displayed.

**DISPLAY:** Displays the current data trace. It is the default display.

**DATA** Key Path: **DISPLAY**, **DISPLAY: DATA**

**EDIT** Displays the edit segment menu, which is used to define or modify the stimulus value and limit values of a specified segment. If the table was empty, a default segment is displayed. The default segment is a sloping line with zero limits and stimulus values that vary according to the current stimulus mode (distance or time).

Key Path: **SYSTEM**, **LIMIT MENU**, **EDIT LIMIT LINE**, **EDIT**

**EDIT LIMIT LINE** Displays the table of limit lines on the screen so that the segments can be seen or changed.

Key Path: **SYSTEM**, **LIMIT MENU**, **EDIT LIMIT LINE**

**ENTRY OFF** Prevents accidental changes to the active function. After this key is pressed, turning the front-panel data entry knob will not change any parameters.

**ERASE TITLE** Deletes the entire title and the “hp” logo.

Key Path: **DISPLAY**, **TITLE**, **ERASE TITLE**

Key Path: **SAVE**, **TITLE REGISTER**, **TITLE REGn**, **ERASE TITLE**

Key Path: **SAVE**, **STORE TO DISK**, **TITLE FILES**, **TITLE FILEn**, **ERASE TITLE**

- ext status notation** Indicates that the precision reflectometer is waiting for an external trigger at the rear panel.
- EXT AM connector** This rear-panel connection is not used.
- EXT REF IN connector** This rear-panel connection is not used.
- EXT. TRIG on OFF** Selects external trigger mode. In this mode, the sweep is held until the instrument receives a TTL low signal at its rear-panel **EXT TRIGGER** connector. There is only one sweep per low-going transition.  
Key Path: **MEAS**, **EXT. TRIG on OFF**
- EXT TRIGGER connector** This rear-panel connection is used to connect an external negative-going TTL-compatible signal to trigger a measurement sweep. The trigger can be set to external using the **EXT TRIG on OFF** softkey.
- EXTERNAL** Turns off the internal sources so that an external source can be used. This feature is provided as a convenience for users with very advanced applications. Note that normal calibration and correction features are not available with an external source. Use the entry keys to enter the wavelength of the external source.  
Connect the external source to the rear-panel **SOURCE ARM INPUT** connector. This connector is located behind a cover plate on the lightwave section's rear panel. The cover plate is located just left of the I.O. **INTERCONNECT** cable. The green fiber-optic cable supplies the internal sources and should normally remain connected to this connector. Refer to "Block Diagram" in this chapter.  
Key Path: **MENU**, **EXTERNAL**

**Keys, Softkeys, and Connectors**

**FIXED MKR MENU** Activates the fixed-marker menu, where the time, distance, and amplitude values for a fixed reference marker can be set. The marker can be positioned anywhere on the display, and need not be on the trace. It can be set to the current active marker position, using the **MARKER → FIXED MARKER** softkey. Other markers can then be activated and their values referenced to the fixed marker. When this is done, the marker readings in the top right corner of the graticule are the distance (or time) and amplitude values of the active marker minus the fixed marker. Also displayed in the top right corner is the notation **Δ REF=FIXED**.

Key Path: **(MKR)**, **Δ MENU**, **FIXED MKR MENU**

**FIXED MKR POSITION** Allows you to set a marker at any horizontal position (distance or time). Separate values are not maintained for logarithmic magnitude format and linear magnitude format.

Key Path: **(MKR)**, **Δ MENU**, **FIXED MKR MENU**, **FIXED MKR POSITION**

**FIXED MKR VALUE** Allows you to set the fixed marker at any vertical value (amplitude). Separate values are not maintained for logarithmic magnitude format and linear magnitude format.

Key Path: **(MKR)**, **Δ MENU**, **FIXED MKR MENU**, **FIXED MKR VALUE**

**FIRMWARE REVISION** Pressing this softkey displays the version number of the instrument's internal firmware.

Key Path: **FIRMWARE REVISION**

**FLAT LINE** Defines a flat limit-line segment whose value is constant with distance or time. This line is continuous to the next stimulus value but is not joined to a segment with a different limit value. If a flat line segment is the final segment it terminates at the stimulus stop value. A flat line segment is indicated as FL on the table of limits.

Key Path: **(SYSTEM)**, **LIMIT MENU**, **EDIT LIMIT LINE**, **LIMIT TYPE**, **FLAT LINE**

**FORMAT** Presents softkeys for selecting the format of the vertical and horizontal scales.

**FORMAT ARY** Specifies whether or not to store the formatted data on disk with the  
**on OFF** instrument state.

Key Path: **SAVE**, **STORE TO DISK**, **DEFINE STORE**,  
**FORMAT ARY on OFF**

**FORMAT:** Selects binary data format, which is the faster, more compact data storage  
**BINARY** format. When selected, the following data is formatted in binary:

- Data arrays (corrected)
- Raw data arrays
- Formatted array
- Display memory array

Key Path: **SAVE**, **STORE TO DISK**, **DEFINE STORE**, **DISK FILE FORMAT**,  
**FORMAT: BINARY**

**FRESNEL** Selects the percentage of reflectance from the open end of super PC cable as  
**(3.16%)** the reflection “standard” when the source is 1300 nm.

For every reference extension cable supplied with the HP 8504B, there is a corresponding cable of equal length which may be used as a calibration standard. The return loss of the fiber end is 15 dB, or 3.16% reflection at 1300 nm. ( $10 \text{ Log } 0.0316 = -15 \text{ dB}$ ). A clean cable end is an accurate and repeatable calibration standard.

Key Path: **CAL**, **CALIBRATE MENU**, **CALIBRATE MAGNITUDE**,  
**FRESNEL (3.16%)**

**FRESNEL** Selects the percentage of reflectance from the open end of super PC cable as  
**(3.37%)** the reflection “standard” when the source is 1550 nm.

For every reference extension cable supplied with the HP 8504B, there is a corresponding cable of equal length which may be used as a calibration standard. The return loss of the fiber end is 14.7 dB, or 3.37% reflection at 1550 nm. ( $10 \text{ Log } 0.0337 = -14.7 \text{ dB}$ ). A clean cable end is an accurate and repeatable calibration standard.

**Keys, Softkeys, and Connectors**

Key Path: **CAL**, **CALIBRATE MENU**, **CALIBRATE MAGNITUDE**,  
**FRESNEL (3.37%)**

**FULL PAGE** Draws a full-size plot according to the scale defined with **SCALE PLOT** in the **DEFINE PLOT** menu.

Key Path: **COPY**, **SELECT QUADRANT**, **FULL PAGE**

**FULL SPAN** Sets the source to sweep its full span. The default span is 0 to 400 mm (0 to 1334 ps in time format) when the refraction index, n, equals 1.

Key Path: **MENU**, **FULL SPAN**

**GRAPHICS on OFF** Specifies whether or not to store display graphics on disk with an instrument state.

Key Path: **SAVE**, **STORE TO DISK**, **DEFINE STORE**, **GRAPHICS on OFF**

**GRATICULE TEXT** Presents softkeys for changing the tint, brightness, and color of the graticule and active function.

Key Path: **DISPLAY**, **MORE**, **ADJUST DISPLAY**, **MODIFY COLORS**,  
**GRATICULE TEXT**

**GREEN connector** This rear-panel connector is one of three outputs (RED, GREEN, BLUE) that drive an external monitor. The monitor must have the following characteristics:

- RGB with synch on green
- 75 $\Omega$  impedance
- 1V p-p (0.7V = white; 0V = black; -0.3V = synch)

**GUIDED CAL** This guided procedure provides a convenient way to perform a full instrument calibration. Displayed steps guide the user through a calibration. It takes about two minutes to complete.

Key Path: **CAL**, **GUIDED CAL**

**GUIDED SETUP** This guided procedure provides a convenient way to prepare for measurements. Displayed steps guide the user through selecting a source and performing a calibration. Different steps are presented depending on whether the device being measured has a pigtail. The guided setup takes about two minutes to complete.

Key Path: **PRESET**, **GUIDED SETUP**

Key Path: **SYSTEM**, **GUIDED SETUP**

**Hld status notation** Indicates that the precision reflectometer is waiting for an external trigger signal to initiate a sweep.

**HORIZ: DISTANCE** Sets the horizontal axis to display the sweep in terms of distance. This is the default scale. The default (and maximum) value is 400 mm (200 mm when  $n=2$ , 133.3 mm when  $n=3$ , and so forth). The minimum value is 1 mm (0.5 mm when  $n=2$ , and so forth).

Key Path: **FORMAT**, **HORIZ: DISTANCE**

**HP-IB connector** This rear-panel connection connects the precision reflectometer to an external controller and other instruments in an automated system. It is also used when the precision reflectometer itself is the controller of compatible peripherals such as printers and plotters.

**HP-IB DIAG on OFF** Toggles the HP-IB diagnostic feature (debug mode). This mode is normally used the first time a program is written. If a program has already been debugged, it is unnecessary.

When this diagnostic feature is on, the precision reflectometer scrolls a history of incoming HP-IB commands across the display in the title line. Non-printable characters are represented as  $\pi$ . Any time a syntax error is

**Keys, Softkeys, and Connectors**

received, the commands stop and a pointer ^ indicates the misunderstood character.

Key Path: **LOCAL**, **HP-IB DIAG on OFF**

**INIT DISK? YES** Initializes the diskette. If the diskette is damaged, the message **INITIALIZATION FAILED** is displayed. During the initialization process, the message **WAITING FOR DISK** is displayed. This is normal.

Key Path: **SAVE**, **STORE TO DISK**, **DEFINE STORE**, **INITIALIZE DISK**, **INIT DISK? YES**

**INITIALIZE DISK** Activates the initialize menu. Initialization formats the disk in an external disk drive. The format used is LIF. If you attempt to store without initializing the disk, the message **CAUTION: DISK MEDIUM NOT INITIALIZED** is displayed.

Key Path: **SAVE**, **STORE TO DISK**, **DEFINE STORE**, **INITIALIZE DISK**

**INTENSITY** Adjusts the screen intensity from 0% (off) to 100%. This intensity adjustment is not affected by **PRESET**, **MODIFY COLORS**, **DEFAULT COLORS**, **SAVE COLORS**, or **RECALL COLORS**.

Key Path: **DISPLAY**, **MORE**, **ADJUST DISPLAY**, **INTENSITY**

**I/O INTERCONNECT connector** This rear-panel connection is located on both the lightwave and display processor sections. It provides essential signal interconnection lines between the instrument sections.

**LEFT LOWER** Draws a quarter-page plot in the lower left quadrant of the page.

Key Path: **COPY**, **SELECT QUADRANT**, **LEFT LOWER**



**LEFT UPPER** Draws a quarter-page plot in the upper left quadrant of the page.

Key Path: **COPY**, **SELECT QUADRANT**, **LEFT UPPER**

**LIMIT LINE OFFSETS** Leads to the offset limits menu, which is used to offset all limit-lines set by a user-defined amount.

Key Path: **SYSTEM**, **LIMIT MENU**, **LIMIT LINE OFFSETS**

**LIMIT LINE on OFF** Turns limit lines on or off. When on, defined limit lines are displayed on the screen for visual comparison with the measured data.

Key Path: **SYSTEM**, **LIMIT MENU**, **LIMIT LINE on OFF**

**LIMIT MENU** Presents a menu for creating limit lines. Limit lines can be used for “pass/fail” testing of devices.

Key Path: **SYSTEM**, **LIMIT MENU**

**LIMIT TEST on OFF** Turns limit-line testing on or off. When limit-line testing is on, the data is compared with the defined limits at each measured point. Limit tests occur at the end of each sweep, whenever the data is updated, when formatted data is changed, and when limit testing is first turned on.

Key Path: **SYSTEM**, **LIMIT MENU**, **LIMIT TEST on OFF**

**LIMIT TYPE** Leads to the limit type menu, where one of three segment types can be selected.

Key Path: **SYSTEM**, **LIMIT MENU**, **EDIT LIMIT LINE**, **LIMIT TYPE**

**LIN MAG** Displays the magnitude data in linear format. This format is scaled but unitless.

Key Path: **FORMAT**, **LIN MAG**

**Keys, Softkeys, and Connectors**

**LINE TYPE DATA** Selects the line type for plotting the data trace. The default line type is 7, which is a solid unbroken line.

Key Path: **COPY**, **CONFIGURE PLOT**, **LINE TYPE DATA**

**LINE TYPE MEMORY** Selects the line type for plotting the memory trace. The default line type is 7, which is a solid unbroken line.

Key Path: **COPY**, **CONFIGURE PLOT**, **LINE TYPE MEMORY**

**LIST VALUES** Provides a tabular listing of all the measured stimulus points and their current data values, together with limit information if it is turned on. At the same time, the screen menu is presented, to enable hard copy listings and access new pages of the table. Thirty lines of data (maximum) are listed on 14 pages (screens).

Up to five columns of information are provided. The specific information listed for each measured stimulus point varies depending on the display format and the limit testing status. If limit testing is on, an asterisk \* is listed next to any measured value that is out of limits. If limit lines are on, and other listed data allows sufficient space, the limits are listed together with the margin by which the device data passes or fails the nearest limit.

Key Path: **COPY**, **LIST VALUES**

**LOAD FILEn** Restores the instrument state contained in file 1, 2, 3, 4, or 5. The current instrument state is overwritten.

Key Path: **RECALL**, **LOAD FROM DISK**, **LOAD FILEn**

**LOCAL** Presents menus for setting HP-IB addresses and selecting the HP-IB operating mode. During HP-IB control, pressing this key returns local control of the instrument so that it responds to front-panel control.

**LOAD FROM DISK** Accesses a menu that is used to restore instrument states previously stored to disk.

Key Path: **RECALL**, **LOAD FROM DISK**

**LOWER LIMIT** Sets the lower limit response value for the start of the segment. If an upper limit is specified, a lower limit must also be defined. If no lower limit is required for a particular measurement, force the lower limit value out of range (for example  $-200$  dB).

Key Path: **SYSTEM**, **LIMIT MENU**, **EDIT LIMIT LINE**, **EDIT**, **LOWER LIMIT**

**MARKER → CENTER** Changes the distance (or time) center value to the value of the active marker and centers the span about that value.

Key Path: **MKR FCTN**, **MARKER → CENTER**

**MARKER → FIXED MKR** Causes a fixed marker to be placed at the position of the active marker. Any active marker on the screen shows the difference in values between itself and this active marker. Marker readings in the screen's top-right corner are in distance (or time) and amplitude values. Also displayed in the top right corner is the notation  $\Delta$  REF=FIXED.

Marker values are displayed in millimeters for distance format, and picoseconds for time format. In logarithmic magnitude format, the vertical amplitude units are displayed in dB. In linear magnitude format, vertical amplitude is displayed in "units."

This feature is especially useful when used with **MARKER  $\Delta$  → SPAN**.

Key Path: **MKR FCTN**, **MARKER → FIXED MKR**

Key Path: **MKR**, **MARKER → FIXED MKR**

**Keys, Softkeys, and Connectors**

**MARKER → REFERENCE** → Sets the reference value equal to the value of the active marker. In effect, the marker moves to the reference line and moves the data trace with it.

Key Path: **SCALE REF**, **MARKER → REFERENCE**

**MARKER → START** → Changes the distance (or time) start value to the value of the active marker.

Key Path: **MKR FCTN**, **MARKER → START**

**MARKER → STOP** → Changes the distance (or time) stop value to the value of the active marker.

Key Path: **MKR FCTN**, **MARKER → STOP**

**MARKER → AMP. OFS.** → Uses the active marker to set the amplitude offset. Move the marker to the desired middle value of the limits and press this softkey. The limits are then moved so that they are centered an equal amount above and below the marker at that stimulus value.

Key Path: **SYSTEM**, **LIMIT MENU**, **LIMIT LINE OFFSETS**,  
**MARKER → AMP. OFS.**

**MARKER → MIDDLE** → Sets the midpoint for **DELTA LIMITS** using the active marker to set the middle magnitude value of a limit segment. Move the marker to the desired value or device specification, and press this key to make that value the midpoint of the delta limits. The limits are automatically set an equal amount above and below the marker.

Key Path: **SYSTEM**, **LIMIT MENU**, **EDIT LIMIT LINE**, **EDIT**,  
**MARKER → MIDDLE**

**MARKER → POSITION** → Sets the starting stimulus value of a segment using the active marker. Move the marker to the desired starting stimulus value before pressing this key, and the marker stimulus value is entered as the segment start value.

Key Path: **SYSTEM**, **LIMIT MENU**, **EDIT LIMIT LINE**, **EDIT**,  
**MARKER → POSITION**

**MARKER n** Turns on marker 1, 2, 3, or 4 and makes it the active marker. The active marker appears on the display as the  $\nabla$  symbol. The active marker's distance (or time) value as well as its amplitude are displayed in the active entry area. The horizontal position can be controlled with the front-panel knob, the number pad, or the step keys. The step keys move the marker in one-division increments on the graticle. The marker amplitude and distance (or time) values are also displayed in the upper right-hand corner of the screen.

If another marker key is pressed, the original marker becomes inactive and is represented on the screen as the  $\Delta$  symbol. Only the most recently selected marker is active.

Key Path: **(MKR)**, **MARKER n**

**MARKER  $\Delta$   $\rightarrow$  SPAN** Changes the start and stop distance (or time) parameters to the values of the active marker and the delta reference markers, respectively.

Key Path: **(MKR FCTN)**, **MARKER  $\Delta$   $\rightarrow$  SPAN**

**MAX SEARCH** Places the marker on the displayed data point having the greatest amplitude value. With delta markers, the marker is placed on the data point having the greatest amplitude value. The function does not search for the greatest-amplitude data point repeatedly; it searches once each time the **MAX SEARCH** key is pressed.

Key Path: **(MKR FCTN)**, **MAX SEARCH**

Key Path: **(MKR FCTN)**, **PEAK SEARCH**, **MAX SEARCH**

**(MEAS)** This key presents a menu that allows you to set the index of refraction ( $n$ ) and access trigger functions. If the instrument times out and stops sweeping, press the **MEASURE RESTART** softkey.

**Keys, Softkeys, and Connectors**

**MEASURE RESTART** This softkey resets averaging to 0 (zero) and performs one of two actions:

- If the instrument is sweeping, it stops the current sweep and starts a new sweep.
- If the instrument is not sweeping (in hold mode), it starts a single sweep.

Key Path: **MEAS**, **MEASURE RESTART**

**MEASURE STANDARD** During calibrations, this softkey starts the magnitude calibration.

Key Path: **CAL**, **CALIBRATE MENU**, **CALIBRATE MAGNITUDE**, **MEASURE STANDARD**

**MEMORY** Displays the active trace memory 1 or 2.

Key Path: **DISPLAY**, **MEMORY**

**MEMORY 1** In the first-level of the **DISPLAY** menu, selects memory 1 as the active trace memory. The active memory is the one displayed, stored to, or otherwise changed by memory functions.

Under the **DISPLAY** menu's **MODIFY COLORS**, presents softkeys for changing the tint, brightness, and color of the displayed memory 1 trace.

Key Path: **DISPLAY**, **MEMORY 1**

Key Path: **DISPLAY**, **MORE**, **ADJUST DISPLAY**, **MODIFY COLORS**, **MEMORY 2 REF LINE**

**MEMORY 2** Selects memory 1 as the active trace memory. The active memory is the one displayed, stored to, or otherwise changed by memory functions.

Key Path: **DISPLAY**, **MEMORY 2**

**MEMORY 2 REF LINE** Presents softkeys for changing the tint, brightness, and color of the displayed memory 2 trace and the reference line.

Key Path: **DISPLAY**, **MORE**, **ADJUST DISPLAY**, **MODIFY COLORS**,  
**MEMORY 2 REF LINE**

**MENU** Presents a menu for selecting the source, and changing the instrument's horizontal measurement span.

**MIDDLE VALUE** Sets the midpoint for limit line **DELTA LIMITS**. It sets a specified magnitude value vertically centered between the limits.

Key Path: **MIDDLE VALUE**

**MKR** Displays a menu of basic marker functions including normal, fixed, and delta markers.

**MKR FCTN** Displays a menu of marker functions that can be used to perform peak searches and change the measurement range.

**MKR VALUES ON off** Causes inactive marker data to be shown in the upper right-hand corner of the display, below the active marker data. The data consists of amplitude and distance (or time) information. The inactive marker or markers must be selected previously in order for their data to be displayed. When turned off, all inactive marker data is removed from the display, leaving only the active marker data.

Key Path: **MKR**, **MKR VALUES ON off**

**MKR ZOOM** Moves the active marker to the nearest peak, centers it on the display, and decreases the span around the peak. This function makes it easy to view the details of a peak response and see any nearby responses. Each time the **MKR ZOOM** is pressed, the span is decreased in a 5-2-1 sequence. For example, if the current span is 0 mm to 400 mm, repeatedly pressing this softkey decreases the span to 50, 20, 10, 5, 2, and 1 mm (1.2 mm for the 1550 nm band). The span value is shown on the bottom right-hand edge of the screen. If there is no active marker, marker 1 is activated and seeks the nearest peak from the far right-hand edge of the trace.

**Keys, Softkeys, and Connectors**

Key Path: **(MKR FCTN)**, **MKR ZOOM**

**MODIFY COLORS** Presents a menu to modify the colors of the individual screen elements.

Key Path: **(DISPLAY)**, **MORE**, **ADJUST DISPLAY**, **MODIFY COLORS**

**NEXT PEAK HIGHER** Finds the smallest peak which is greater than the current peak.

Key Path: **(MKR FCTN)**, **PEAK SEARCH** **NEXT PEAK HIGHER**

**NEXT PEAK LEFT** Finds the next peak to the left of the current marker position.

Key Path: **(MKR FCTN)**, **PEAK SEARCH** **NEXT PEAK LEFT**

**NEXT PEAK LOWER** Finds the largest peak which is smaller than the current peak.

Key Path: **(MKR FCTN)**, **PEAK SEARCH** **NEXT PEAK LOWER**

**NEXT PEAK RIGHT** Finds the next peak to the right of the current marker position.

Key Path: **(MKR FCTN)**, **PEAK SEARCH** **NEXT PEAK RIGHT**

**OP PARMS (MKRS etc)** Provides a tabular listing of key parameters. The screen menu allows printing or plotting of the parameters visible or paging through two pages of information. The information consists of marker and system parameters. System parameters relate to control of peripheral devices.

Key Path: **(COPY)**, **OP PARMS (MKRS etc)**

**OUTPUT (TO AUX INPUT) connector** This rear-panel connection is used to connect DC or AC voltages from the lightwave section to the display processor for display and measurement processing.



**OVL status notation** Indicates that the amplitude of the source is too large for the current application.

**PEAK EXCURSION** Defines what constitutes a peak in the trace. The value specifies the amount that a trace must increase and then decrease, relative to the surrounding responses or noise floors in order to be defined as a peak. Upon entering a value, complete the entry with **[x1]**.

Key Path: **[MKR FCTN]**, **PEAK SEARCH**, **DEFINE PEAK**, **PEAK EXCURSION**

**PEAK SEARCH** Selects the peak search menu, which provides choices of the type of peak search desired.

Key Path: **[MKR FCTN]**, **PEAK SEARCH**

**PEAK THRESHOLD** Sets the level below which nothing will be considered a peak. The maximum amplitude of the response must be at least this value to be called a peak. The allowable threshold values range from  $-100$  to  $0$  dB. The default value is  $-70$  dB. Upon entering a value, complete the entry with **[x1]**.

Any part of a peak (as defined by peak excursion) that is less than the peak threshold value is also used to satisfy the peak excursion criteria. For example, when the peak excursion is set to  $8$  dB, a peak that is  $4$  dB above and  $4$  dB below the peak threshold will be considered a peak.

Key Path: **[MKR FCTN]**, **PEAK SEARCH**, **DEFINE PEAK**, **PEAK THRESHOLD**

**PEAK TRACK on OFF** Moves the active marker to the nearest peak if it is not on a peak when the function is enabled. Peak tracking is updated when the function is first enabled and at the end of every sweep.

Key Path: **[MKR FCTN]**, **PEAK SEARCH**, **PEAK TRACK on OFF**

**Keys, Softkeys, and Connectors**

- PEN NUM DATA** Selects the number of the pen to plot the data trace. The default is pen number 1.  
Key Path: **COPY**, **CONFIGURE PLOT**, **PEN NUM DATA**
- PEN NUM GRATICULE** Selects the pen number for plotting the graticule. The default is pen number 3.  
Key Path: **COPY**, **CONFIGURE PLOT**, **PEN NUM GRATICULE**
- PEN NUM MARKER** Selects the pen number for plotting both the markers and the marker values. The default is pen number 5.  
Key Path: **COPY**, **CONFIGURE PLOT**, **PEN NUM MARKER**
- PEN NUM MEMORY** Selects the number of the pen to plot the memory trace. The default is pen number 1.  
Key Path: **COPY**, **CONFIGURE PLOT**, **PEN NUM MEMORY**
- PEN NUM TEXT** Selects the pen number for plotting the text. The default is pen number 1.  
Key Path: **COPY**, **CONFIGURE PLOT**, **PEN NUM TEXT**
- PLOT** Plots the display to a compatible graphics plotter using the currently defined plot parameters or default parameters. Any or all displayed information can be plotted, except a limit table or the softkey labels. Tabular listings can be plotted, although plotting is considerably slower than printing.  
Key Path: **COPY**, **PLOT**
- PLOT DATA ON off** Specifies whether the data trace is to be drawn or not drawn on the plot.  
Key Path: **COPY**, **DEFINE PLOT**, **PLOT DATA ON off**

**PLOT GRAT** Specifies whether the graticule and the reference line are to be drawn or not drawn on the plot.  
**ON off**

Key Path: **(COPY)**, **DEFINE PLOT**, **PLOT GRAT ON off**

**PLOT MEM** Specifies whether the memory trace is to be drawn or not drawn on the plot.  
**ON off** Memory can only be plotted if it is displayed.

Key Path: **(COPY)**, **DEFINE PLOT**, **PLOT MEM ON off**

**PLOT MKR** Specifies whether the markers and marker values are to be drawn or not drawn on the plot.  
**ON off**

Key Path: **(COPY)**, **DEFINE PLOT**, **PLOT MKR ON off**

**PLOT SPEED** Provides two plot speeds: **FAST** and **SLOW**. Use **SLOW** for plotting directly on transparencies because the slower speed provides a more consistent line width. A color plot can be prepared directly on a transparency so that the color is not lost in converting a paper plot to a transparency.

Key Path: **(COPY)**, **DEFINE PLOT**, **PLOT SPEED**

**PLOT TEXT** Selects plotting of all displayed text except limits table, softkeys, and marker values.  
**ON off**

Key Path: **(COPY)**, **DEFINE PLOT**, **PLOT TEXT ON off**

**POSITION** Moves the limits horizontally (by adding or subtracting an offset in stimulus value). This allows limits already defined to be used for testing in a different stimulus range.  
**OFFSET**

Key Path: **(SYSTEM)**, **LIMIT MENU**, **LIMIT LINE OFFSETS**,  
**POSITION OFFSET**

**Keys, Softkeys, and Connectors**

**POSITION VALUE** Sets the starting distance (or time) value of a segment with the entry keys. The ending value of the segment is defined by the start of the next segment. No more than one segment can be defined over the same stimulus range.

Key Path: **SYSTEM**, **LIMIT MENU**, **EDIT LIMIT LINE**, **EDIT**, **POSITION VALUE**

**PRESET** When this key is pressed, the instrument performs a self test and then returns to predefined state. The predefined state has the following settings:

Band .....	1300 nm
Start .....	0 mm
Stop .....	400 mm
Sweep .....	continuous
Horizontal units .....	distance
N value .....	1
Displayed trace .....	data
Vertical units .....	log mag
Vertical scale .....	10 dB/division
Reference level .....	-50 dB
Markers .....	off
Averaging .....	off
Correction .....	off
Dispersion correction .....	off
HP-IB mode .....	talker/listener

**PRINT** Copies the display to a compatible HP graphics printer. Tabular listings or data displays can be printed, although a plotter provides better resolution for data displays. All information from the screen is printed except the softkey labels.

If list values are being printed, copies one page of the tabular listings to a compatible Hewlett Packard graphics printer connected to the precision reflectometer over HP-IB.

Key Path: **COPY**, **PRINT**

Key Path: **COPY**, **PRINT/PLOT SETUPS**, **COLOR**

**PRINT/PLOT SETUPS** Presents a menu to select a standard (non-color) or color printer as the default, and lets you reset the print and plot definitions.

Key Path: **COPY**, **PRINT/PLOT SETUPS**

**SERVICE MENU** This softkey provides access by the factory to special service functions. It is not accessible to normal users.

Key Path: **SYSTEM**, **SERVICE MENU**

**PRINT: STANDARD** Specify a non-color printer.

Key Path: **PRINT: STANDARD**

**PURGE FILEn** Removes file 1, 2, 3, 4, or 5 from the disk. If no file of that name is on the disk, the message **CAUTION: NO FILE(S) FOUND ON DISK** appears.

Key Path: **SAVE**, **STORE TO DISK**, **DEFINE STORE**, **PURGE FILES**, **PURGE FILEn**

**PURGE FILES** Activates the purge files menu, which is used to remove the information stored on an external disk.

Key Path: **SAVE**, **STORE TO DISK**, **DEFINE STORE**, **PURGE FILES**

**RAW ARRAY on OFF** Specifies whether or not to store the raw data (averaged) on disk with the instrument state.

Key Path: **SAVE**, **STORE TO DISK**, **DEFINE STORE**, **RAW ARRAY on OFF**

**READ FILE TITLES** Searches the disk directory for file names recognized as belonging to an instrument state. No more than five titles are displayed at one time. If there are more than five, repeatedly pressing this key causes the next five to be displayed. If there are fewer than five, the remaining softkey labels are blanked.

Key Path: **RECALL**, **LOAD FROM DISK**, **READ FILE TITLES**

**Keys, Softkeys, and Connectors**

Key Path: **SAVE**, **STORE TO DISK**, **DEFINE STORE**, **PURGE FILES**,  
**READ FILE TITLES**

**RECALL** This menu lets you recall data from instrument-state registers and an external disk drive.

**RECALL COLORS** Recalls any previously saved screen color modifications. This key is not visible unless color modifications have been saved.

Key Path: **DISPLAY**, **MORE**, **ADJUST DISPLAY**, **RECALL COLORS**

**RECALL REGn** Recalls the instrument state saved in register 1, 2, 3, 4, or 5. The current instrument state is overwritten.

Key Path: **RECALL**, **RECALL REGn**

**RECEIVER ARM OUTPUT connector** This rear-panel connection allows direct input to the optical detector. The yellow fiber-optic cable should normally remain connected to this connector. Refer to “Block Diagram” in this chapter.

**RED connector** This rear-panel connector is one of three outputs (RED, GREEN, BLUE) that drive an external monitor. The monitor must have the following characteristics:

- RGB with synch on green
- 75 $\Omega$  impedance
- 1V p-p (0.7V = white; 0V = black; -0.3V = synch)

**REFERENCE EXTENSION A connector** Attach the reference fiber-optic cable to this front-panel output connector. The output at this connector is 1300 nm or 1550 nm at a power level that is less than the value listed in “Characteristics” in Chapter 6 for the **TEST PORT** connector. Refer to “Block Diagram” in this chapter.

- REFERENCE EXTENSION B connector** Attach the reference fiber-optic cable to this front-panel input connector. The input wavelength is 1300 nm or 1550 nm from the **REFERENCE EXTENSION B** connector. Refer to “Block Diagram” in this chapter.
- REFERENCE POSITION** Sets the position of the reference line on the screen. The default value is five divisions up (the middle of the screen). The reference line is normally red and further identified by a small triangle at the left edge of the graticule.  
Key Path: **SCALE REF**, **REFERENCE POSITION**
- REFERENCE VALUE** Sets the value of the reference line. The default value is  $-50$  dB. Its range is 200 dB to  $-200$  dB.  
Key Path: **SCALE REF**, **REFERENCE VALUE**
- REFRACTIVE INDEX (n)** Sets the refractive group index number. The default (and minimum) value is 1, and the maximum is 200. The refractive index value is displayed on the bottom of the screen as **n=1**.  
Key Path: **MEAS**, **REFRACTIVE INDEX (n)**
- RESET COLOR** Resets the selected screen element to its default color.  
Key Path: **DISPLAY**, **MORE**, **ADJUST DISPLAY**, **MODIFY COLORS**, **DATA LIMIT LN**, **RESET COLOR**
- RESTORE DISPLAY** Turns off the tabular listing, and returns the measurement display to the screen.  
Key Path: **COPY**, **LIST VALUES**, **RESTORE DISPLAY**  
Key Path: **COPY**, **OP PARMS (MKRS etc)**, **RESTORE DISPLAY**

- RIGHT LOWER** Draws a quarter-page plot in the lower-right quadrant of the page.  
Key Path: **COPY**, **SELECT QUADRANT**, **RIGHT LOWER**
- RIGHT UPPER** Draws a quarter-page plot in the upper-right quadrant of the page.  
Key Path: **COPY**, **SELECT QUADRANT**, **RIGHT UPPER**
- SAVE** This menu let you save data to instrument-state registers, store data to an external disk drive, and recall data from either.
- SAVE COLORS** Saves any screen color modifications. These changes are not affected by **PRESET**, but cycling power returns the default settings.  
Key Path: **DISPLAY**, **MORE**, **ADJUST DISPLAY**, **SAVE COLORS**
- SAVE REGn** Saves memory trace 1 or 2 to an internal register 1, 2, 3, 4, or 5. The learn string is also saved in non-volatile memory.  
Key Path: **SAVE**, **SAVE REGn**
- SCALE (/DIV)** Changes the vertical scale's per-division value (and thus the size of the trace). Scale per division is noted at the top edge of the screen; for example 10 dB/.  
Key Path: **SCALE REF**, **SCALE (/DIV)**
- SCALE PLOT** Provides two selections for plot scale: **FULL** and **GRAT**.  
Select **FULL** as the normal scale selection for plotting on blank paper. It includes space for all display annotations such as marker values, stimulus values, and so forth. The entire display fits within the user-defined boundaries of P1 and P2 on the plotter, while maintaining the same aspect ratio as the display.  
With the selection of **GRAT**, the horizontal and vertical scales are expanded or reduced so that the graticule lower left and upper right corners exactly correspond to the user-defined P1 and P2 scaling points on the plotter. This is convenient for plotting on preprinted forms. To plot on a rectangular



preprinted graticule, set P1 of the plotter at the lower left corner of the preprinted graticule, and set P2 at the upper right corner.

Key Path: **COPY**, **DEFINE PLOT**, **SCALE PLOT**

**SCALE REF** This key presents a menu that has autoscale functions for easy scaling of data.

**SEGMENT** Specifies which limit-line segment in the table is to be modified. A maximum of three sets of segment values are displayed at one time, and the list can be scrolled up or down to show other segment entries. Use the entry block controls to move the pointer > to the desired segment number. The indicated segment can then be edited or deleted.

Key Path: **SYSTEM**, **LIMIT MENU**, **EDIT LIMIT LINE**, **SEGMENT**

**SELECT LETTER** Adds the character indicated by the arrow. The active entry area displays the letters of the alphabet, digits 0 through 9, and mathematical symbols. Rotate the front-panel knob until the arrow points at a letter, and then press **SELECT LETTER**. For titles shown on the display, up to fifty characters and spaces can be added. The mathematical symbols are not used when creating register titles.

Key Path: **DISPLAY**, **TITLE**, **SELECT LETTER**

Key Path: **SAVE**, **TITLE REGISTER**, **TITLE REGn**, **SELECT LETTER**

Key Path: **SAVE**, **STORE TO DISK**, **TITLE FILES**, **TITLE FILEn**, **SELECT LETTER**

**SELECT QUADRANT** Accesses the select quadrant menu, which allows drawing quarter-page plots. This is not used for printing.

Key Path: **COPY**, **SELECT QUADRANT**

**Keys, Softkeys, and Connectors**

**SET ADDRESSES** Accesses the address menu which is used to set the HP-IB address of the precision reflectometer and to display and modify the addresses of peripheral devices in the system.

Key Path: **LOCAL**, **SET ADDRESSES**

**SINGLE** Takes one sweep of data and returns to the hold mode.

Key Path: **MEAS**, **SINGLE**

**SINGLE POINT** Sets the limits at a single stimulus point. If limit lines are on, the upper limit value of a single point limit is displayed as  $\nabla$ , and the lower limit is displayed as  $\Delta$ . A limit test at a single point not terminating a flat or sloped line tests the nearest actual measured data point.

A single point limit can be used as a termination for a flat line or sloping line limit segment. When a single point terminates a sloping line or when it terminates a flat line and has the same limit value as the flat line, the single point is not displayed as  $\Delta$  or  $\nabla$ . The indication for a single point segment in the displayed table of limits is SP.

Key Path: **SYSTEM**, **LIMIT MENU**, **EDIT LIMIT LINE**, **LIMIT TYPE**, **SINGLE POINT**

**SLOPING LINE** Defines a sloping limit line segment that is linear with distance or time, and is continuous to the next stimulus value and limit. If a sloping line is the final segment it becomes a flat line terminated at the stimulus stop value. A sloping line segment is indicated as SL on the displayed table of limits.

Key Path: **SYSTEM**, **LIMIT MENU**, **EDIT LIMIT LINE**, **LIMIT TYPE**, **SLOPING LINE**

**SOURCE ARM INPUT connector** This rear-panel connection allows you to use an external source. The green fiber-optic cable supplies the internal sources and should normally remain connected to this connector. Refer to “Block Diagram” in this chapter.

**SOURCE: OFF** Turns off the internal light sources.

Key Path: **(MENU)**, **SOURCE: OFF**

**SPACE** Adds a space to the title. Do not use this softkey in defining a register title.

Key Path: **(DISPLAY)**, **TITLE**, **SPACE**

Key Path: **(SAVE)**, **TITLE REGISTER**, **TITLE REGn**, **SPACE**

Key Path: **(SAVE)**, **STORE TO DISK**, **TITLE FILES**, **TITLE FILEn**, **SPACE**

**(SPAN)** Sets the horizontal measurement range. The default setting is 400 mm which has a time scale equivalent of about 1334 ps. When the refractive index is one, the following minimum spans are available:

minimum value for 1300 nm: ..... 1 mm  
 minimum value for 1550 nm: ..... 1.2 mm

The maximum measurement span is dependent on the refractive index of the light path as shown in the equation

$$maximum\ span = \frac{400\ mm}{n}$$

where  $n$  is the index of refraction.

**(START)** Sets the start value of the horizontal measurement range. The default setting is 0 mm and the minimum setting is 0 mm or 0 ps.

**(STOP)** Sets the stop value of the horizontal measurement range. The maximum setting is dependent on the refractive index of the light path as shown in the equation

$$maximum\ span = \frac{400\ mm}{n}$$

where  $n$  is the index of refraction.

The maximum time setting is 1334 ps. It is not affected by  $n$ .

**Keys, Softkeys, and Connectors**

**STORE FILE<sub>n</sub>** Stores the current instrument state in external file 1, 2, 3, 4, or 5, together with any data specified in the define store menu.

Key Path: **SAVE**, **STORE TO DISK**, **STORE FILE<sub>n</sub>**

**STORE TO DISK** Leads to the store file menu which introduces a series of menus for external disk storage.

Key Path: **SAVE**, **STORE TO DISK**

**SYSTEM** This key presents a menu for guided setups, limit lines, and displaying the firmware revision.

**SYSTEM CONTROLLER** Select this HP-IB mode when peripheral devices are to be used and there is no external controller. As the system controller, the HP 8504B can directly control peripherals (plotter, printer, or disk drive). System controller mode must be set in order for the HP 8504B to access peripherals from the front panel to plot, print, or store on disk. If there is no other controller on the bus, this mode is selected automatically.

The system controller mode can be used without knowledge of HP-IB programming. However, the HP-IB addresses displayed in the address menu must match the addresses set in the peripheral instruments.

This mode can also be selected manually from the front panel and, again, can be used only if no active computer controller is connected to the system through HP-IB. If you try to set system controller mode when another controller is present, the message **CAUTION: CAN'T CHANGE-ANOTHER CONTROLLER ON BUS** is displayed. Do not try to use this mode for programming.

Key Path: **LOCAL**, **SYSTEM CONTROLLER**

**TALKER/ LISTENER** This HP-IB mode normally used for remote programming of the HP 8504B. In this mode, the HP 8504B and all peripheral devices are controlled by the external controller. The controller can command the HP 8504B to talk, and the plotter or other device to listen. The HP 8504B and peripheral devices cannot talk directly to each other unless the computer sets up a data path between them.

A talker is a device capable of sending out data when it is addressed to talk. There can be only one talker at any given time. The HP 8504B is a talker when it sends information over the bus. A listener is a device capable of receiving data when it is addressed to listen. There can be any number of listeners at any given time. The HP 8504B is a listener when it is controlled over the bus by a computer.

Press this key to abort a print or plot in progress.

Key Path: **LOCAL**, TALKER/ LISTENER

**TEST PORT** The device being measured is connected to this front-panel output connector. The output at this connector is 1300 nm or 1550 nm at the power level listed in “Characteristics” in Chapter 6. Refer to “Block Diagram” in this chapter.

**TEXT** Presents softkeys for changing the tint, brightness, and color of displayed text.

Key Path: **DISPLAY**, MORE, ADJUST DISPLAY, MODIFY COLORS, TEXT

**TIME** This mode sets the horizontal scale to display the sweep in terms of time. The default (and maximum) value is 1334 ps; minimum is 0 ps. These values are not affected by the value of the refractive index ( $n$ ).

Key Path: **FORMAT**, TIME

**TINT** Ranges from 0% to 100% and varies the selected element from red to orange, yellow, green, blue, violet, and back to red. If varying tint has no visible effect, increase the color percentage first.

Key Path: **DISPLAY**, MORE, ADJUST DISPLAY, MODIFY COLORS, DATA LIMIT LN, TINT

**TITLE** Presents the title menu for entering a title on the screen.

Key Path: **DISPLAY**, TITLE

**Keys, Softkeys, and Connectors**

**TITLE FILEn** Selects file 1, 2, 3, 4, or 5 to be retitled and activates the title menu.

Key Path: **SAVE**, **STORE TO DISK**, **TITLE FILES**, **TITLE FILEn**

**TITLE FILES** Leads to the title file menu where the default file titles can be modified.

Key Path: **SAVE**, **STORE TO DISK**, **TITLE FILES**

**TITLE REGn** Selects an internal register to be retitled and presents the title menu and the character set.

Key Path: **SAVE**, **TITLE REGISTER**, **TITLE REGn**

**TITLE REGISTER** Leads to the title register menu where the default register titles can be modified.

Key Path: **SAVE**, **TITLE REGISTER**

**TRIGGER: HOLD** Stops the measurement sweep. The sweep is indicated by a red dot moving left to right below the graticule. During retrace (red dot moving right to left), the mirror returns to its start position and then holds. Hold freezes the current data trace on the screen.

Key Path: **MEAS**, **TRIGGER: HOLD**

**UPPER LIMIT** Sets the upper limit response value for the start of the segment. If a lower limit is specified, an upper limit must also be defined. If no upper limit is required for a particular measurement, force the upper limit value out of range (for example +200 dB).

When **UPPER LIMIT** or **LOWER LIMIT** is pressed, all the segments in the table are displayed in terms of upper and lower limits, even if they were defined as delta limits and middle value.

If you attempt to set an upper limit that is lower than the lower limit, or vice versa, both limits will be automatically set to the same value.

Key Path: **SYSTEM**, **LIMIT MENU**, **EDIT LIMIT LINE**, **EDIT**, **UPPER LIMIT**

**USE PASS CONTROL** Allows control of the HP 8504B with the computer over HP-IB as with the talker/listener mode, and also allows the HP 8504B to become the active controller in order to plot, print, or directly access an external disk. During this peripheral operation, the host computer is free to perform other internal tasks that do not require use of the bus. The bus is tied up by the HP 8504B during this time.

The pass control mode requires that the external controller is programmed to respond to a request for control and to issue a take control command. Then the peripheral operation is complete, the HP 8504B passes control back to the computer.

In general, use the talker/listener mode for programming the HP 8504B unless direct peripheral access is required.

Key Path: **LOCAL**, **USE PASS CONTROL**

**USER STD [10%]** Selects a reflectance percentage value when an optional user-defined value is desired (not necessarily 10%). The default value is given as 10% and is changed using the knob, number keys, or step keys. This process is used when you have an optical device of known reflectance that you can use to calibrate the magnitude. This process improves dynamic accuracy.

Key Path: **CAL**, **CALIBRATE MENU**, **CALIBRATE MAGNITUDE**,  
**USER STD [10%]**

**VERT: LOG MAG** Displays the magnitude data in logarithmic format. This is the standard format for displaying return loss in dB versus distance or time.

Key Path: **FORMAT**, **VERT: LOG MAG**

**VOLUME NUMBER** Specifies the volume number of the external disk to be accessed. In general, all 3.5-inch floppy disks are considered one volume (volume 0). For hard disk drives such as the HP 9153A Winchester drive, a switch in the disk drive must be set to define the number of volumes on the disk. Refer to the individual disk drive manual for more information.

Key Path: **LOCAL**, **VOLUME NUMBER**

**WARNING** Presents softkeys for changing the tint, brightness, and color of displayed error messages.

Key Path: **DISPLAY**, **MORE**, **ADJUST DISPLAY**, **MODIFY COLORS**, **WARNING**

**x1** Use this key to terminate unitless entries such as an averaging factor.

**ZERO SPAN on** Sets the center to the former start value and stops the sweep (mirror  
**OFF** movement). In this mode, the precision reflectometer is essentially a  
programmable delay line.

Key Path: **MENU**, **ZERO SPAN on OFF**



# Block Diagram

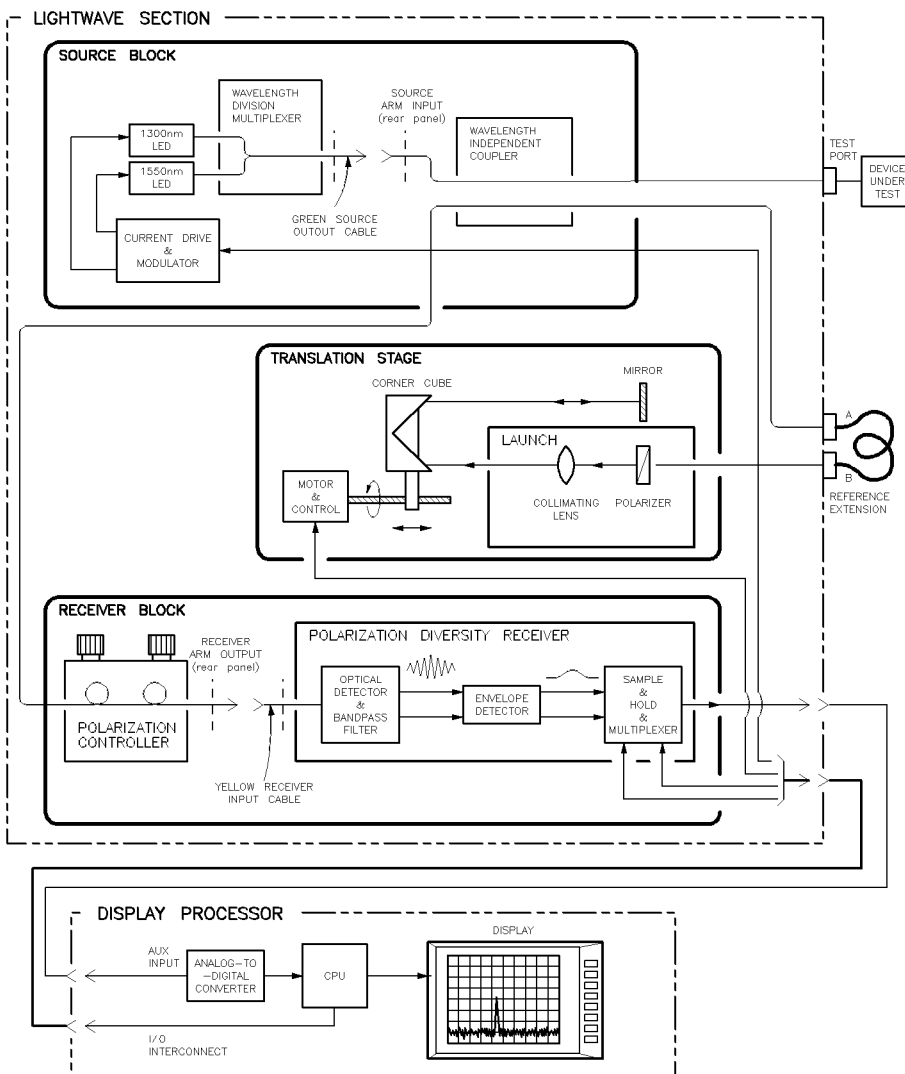

## Front-Panel Fiber-Optic Adapters

The FC/PC adapter is the standard adapter supplied with the instrument.

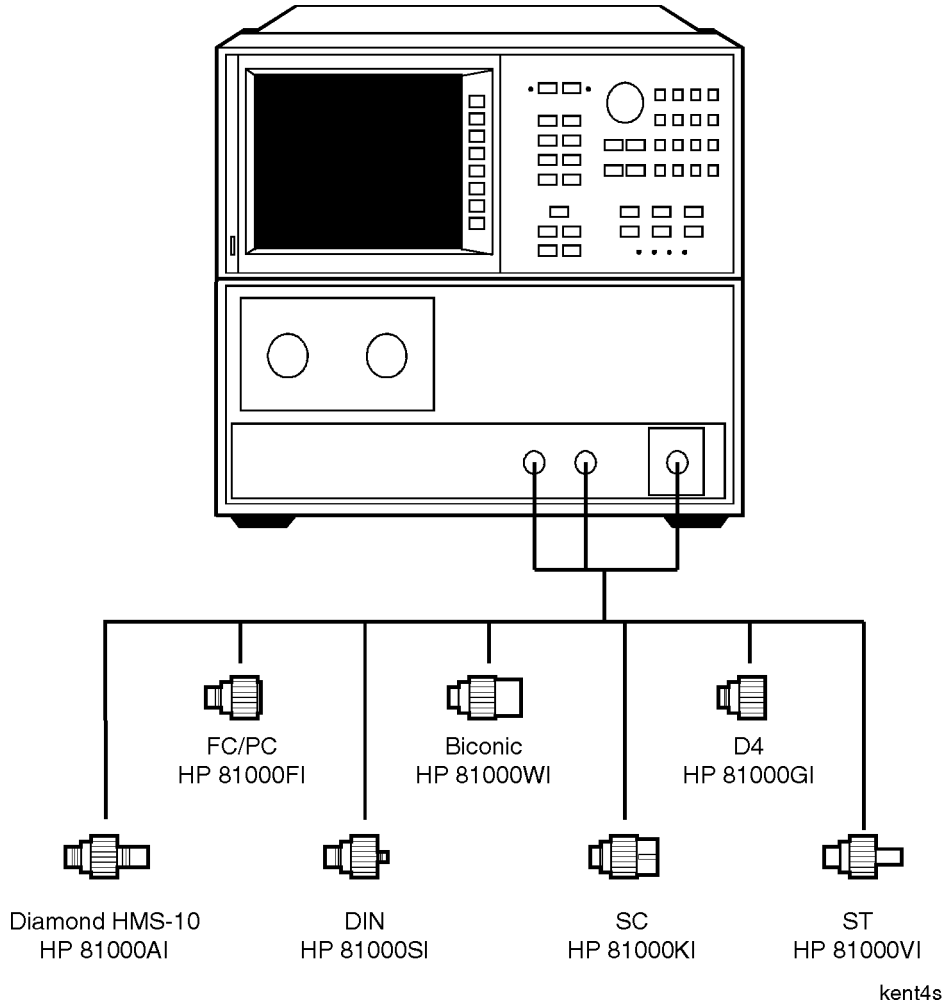

## Part Numbers

Item	HP Part Number
Fiber-optic cable adapter <sup>1</sup>	1005-0089
Low-reflection termination	1005-0178
40 cm FC/PC fiber-optic cable <sup>2</sup>	1005-0173
50 cm FC/PC fiber-optic cable <sup>2</sup>	1005-0174
75 cm FC/PC fiber-optic cable <sup>2</sup>	1005-0175
100 cm FC/PC fiber-optic cable	1005-0176
125 cm FC/PC fiber-optic cable <sup>2</sup>	1005-0177
150 cm FC/PC fiber-optic cable <sup>2</sup>	1005-0171
175 cm FC/PC fiber-optic cable <sup>2</sup>	1005-0172
Cable tray <sup>2</sup>	08504-60030
Isopropyl alcohol cleaner (30 ml)	8500-5344
Cotton swabs	08520-0023
Tape measure (3 m)	8750-0380
Rear-panel BNC cable	8120-1839
Rear-panel IO INTERCONNECT cable	08503-60051
Rear-panel line-power cable <sup>3</sup>	—
Fuse (display processor section): F3.0A, 250V	2110-0780
Fuse (lightwave section): 100V and 120V operation: F1.5A 250V	2110-0043
220V and 240V operation: F0.75A 250V	2110-0063

<sup>1</sup> Used to connect two FC/PC fiber-optic cables.

<sup>2</sup> Part of Option 001 Accessory Kit





<sup>3</sup> Refer to "Line-Power Cables" in this chapter for part number.

---

## Instrument Options

<b>Option</b>	<b>Description</b>
001	Accessory kit
011	HMS-10/HP front-panel test port connector
012	FC/PC front-panel test port connector
013	Din 47256 front-panel test port connector
014	ST front-panel test port connector
015	Biconic front-panel test port connector
1BN	MIL-STD-45662A calibration
1BP	MIL-STD-45662A calibration with data
UK6	Commercial calibration with data

## Line-Power Cables

PLUG TYPE **	CABLE HP PART NUMBER	PLUG DESCRIPTION	CABLE LENGTH CM (INCHES)	CABLE COLOR	FOR USE IN COUNTRY
250V 	8120-1351 8120-1703	Straight* BS1363A 90°	229 (90) 229 (90)	Mint Gray Mint Gray	Great Britain, Cyprus, Nigeria, Singapore, Zimbabwe
250V 	8120-1369 8120-0696	Straight* NZSS198/ASC112 90°	201 (79) 221 (87)	Gray Gray	Argentina, Australia, New Zealand, Mainland China
250V 	8120-1689 8120-1692	Straight* CEE7-Y11 90°	201 (79) 201 (79)	Mint Gray Mint Gray	East and West Europe, Central African Republic, United Arab Republic (unpolarized in many nations)
125V 	8120-1348 8120-1538	Straight* NEMA5-15P 90°	203 (80) 203 (80)	Black Black	United States Canada, Japan (100 V or 200 V), Brazil, Colombia, Mexico, Philippines, Saudia Arabia, Taiwan
	8120-1378	Straight* NEMA5-15P	203 (80)	Jade Gray	
	8120-4753	Straight	230 (90)	Jade Gray	
	8120-1521 8120-4754	90° 90°	203 (80) 230 (90)	Jade Gray Jade Gray	
250V 	8120-5182 8120-5181	Straight* NEMA5-15P 90°	200 (78) 200 (78)	Jade Gray Jade Gray	Israel
<p>* Part number for plug is industry identifier for plug only. Number shown for cable is HP Part Number for complete cable, including plug.</p> <p>** E = Earth Ground; L = Line; N = Neutral.</p>					

FORMAT80

## Reference

---

---

Specifications and  
Regulatory Information

---

# Specifications and Regulatory Information

This chapter contains specifications and characteristics for HP 8504B. The instrument must be stabilized at a temperature within the operating range before it is turned on. A minimum of one hour should be allowed when the instrument has been outside this temperature range. Warranted performance will be achieved only over the restricted temperature range of  $25 \pm 5^\circ\text{C}$ , after a one-hour warmup. The user calibration is only valid for a temperature window of  $\pm 3^\circ\text{C}$  from the original calibration temperature.

## **Verify factory calibration once every year**

Your HP 8504B has been calibrated at the factory. The instrument should be returned to Hewlett-Packard once every year to be recalibrated. Begin timing the first recommended calibration interval from the time when the instrument is first turned on. Do not include shipment and storage time that occurs before the instrument is first turned on.

## **Definitions of Terms**

- *Specifications* describe warranted performance.
- *Characteristics* provide useful, but nonwarranted information about the functions and performance of the instrument. *Characteristics are printed in italics.*



**Contents**

Specifications ..... 6-4  
Characteristics ..... 6-14  
Regulatory Information ..... 6-16

---

# Specifications

---

**CAUTION**

---

This product is designed for use in INSTALLATION CATEGORY II and POLLUTION DEGREE 2, per IEC 1010 and 664 respectively.

---

## LED Classification

International - IEC Class 1. This instrument is rated IEC (International Electrotechnical Commission) Class 1 LED Product according to Publication 825.

# Return Loss Measurement Range

**Description**

The return loss range specifies the range of reflection levels that can be measured. Reflections that are larger than 10 dB, for example 5 dB, may be inaccurate due to receiver saturation. Reflections smaller than 80 dB, for example 85 dB, may be less accurate due to instrument noise floor limitations. At 1550 nm, the 80 dB specification applies only over the 0 to 100 mm mirror position range with dispersion correction enabled. (Refer to “To turn chromatic dispersion correction on and off” in Chapter 2 to learn how to enable the correction data.) The measurement range is degraded due to dispersion effects over the 100 mm to 400 mm range. Refer to “Characteristics” in this chapter to see a display of the noise floor.

**Specification**

<b>Return Loss Measurement Range<sup>1</sup></b>	
1300 nm source:	10 to 80 dB
1550 nm source:	10 to 80 dB <sup>2</sup>

1 Specification applies after 50 averages and minimum span. For 1300 nm, the minimum span is 1 mm. For 1550 nm, the minimum span is 1.2 mm. Dispersion correction must be enabled when using the 1550 nm source.

2 Specification applies over the mirror position range from 0 to 100 mm.

---

## Return Loss Uncertainty

**Description**

Return loss uncertainty gives the possible range of true return-loss values, given a specific measured value. For example, if the measured return loss was  $-57$  dB and the uncertainty was  $+1.8$  dB and  $-1.7$  dB, the true return loss value would lie somewhere between  $-55.2$  dB ( $-57 + 1.8$ ) and  $-58.7$  dB ( $-57 - 1.7$ ). There are five factors which contribute to the return loss uncertainty:

- Dynamic accuracy
- Sweep-to-sweep repeatability
- Polarization sensitivity
- Amplitude flatness versus mirror position
- Dispersion (1550 nm only)

Dynamic accuracy dominates the uncertainty near the noise floor and becomes increasingly less significant at higher signal levels. The specified uncertainty does not include the connector loss or the calibration standard uncertainty.

The return-loss uncertainty graph for the 1550 nm source applies to the mirror position range of 0 to 100 mm. The uncertainty is degraded near  $-80$  dB for mirror positions between 100 and 400 mm due to dispersion effects. Refer to “Characteristics” in this chapter for information on the noise floor.

**Specification**

Return loss uncertainty specification applies with minimum span, averaging on, and the averaging factor set to 50. For 1300 nm, the minimum span is 1 mm. For 1550 nm, the minimum span is 1.2 mm. For 1550 nm, dispersion correction must be enabled and the specification applies over the 0 to 100 mm mirror position range.

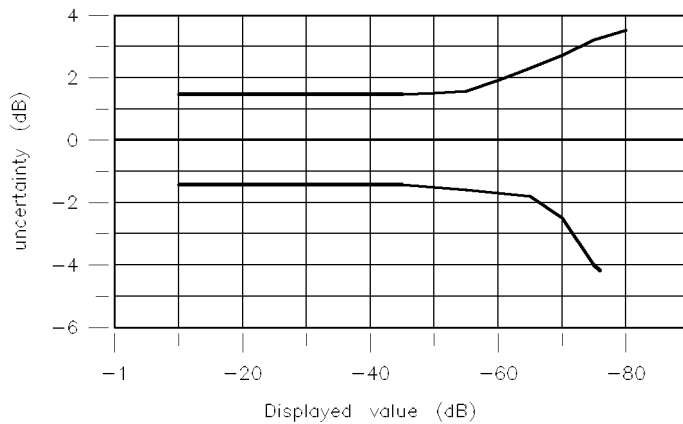

retrnlos

**1300 nm Specification**

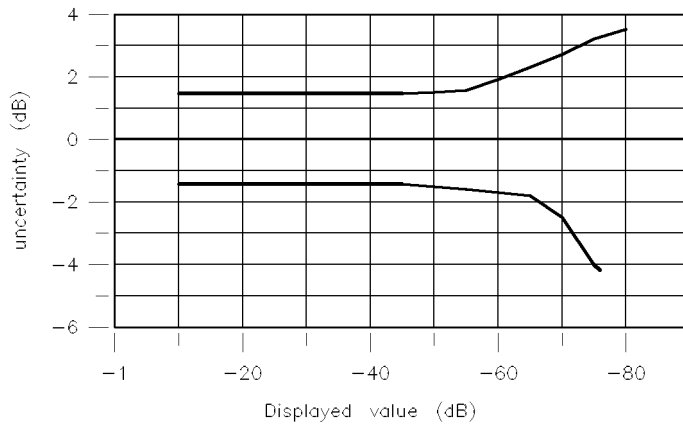

retrnlos

**1550 nm Specification**

**Specifications**

---

## Sweep-to-Sweep Repeatability

**Description**

Sweep-to-sweep repeatability is the sweep-to-sweep amplitude variation seen when measuring a known stable reflection. It does not include noise effects when measuring reflections near the noise floor.

The repeatability is primarily a function of the mechanical mirror translation stage in the interferometer. When evaluating this performance parameter, it is important that the **REFERENCE EXTENSION** cables and the **TEST PORT** cable are held in place, as movement of these components can affect the measurement. Repeatability is measured with a 15 dB Fresnel reflection.

**Specification**

<b>Sweep-To-Sweep Repeatability:</b>	$\pm 0.5$ dB
--------------------------------------	--------------

## Two-Event Spatial Accuracy

**Description**

Two-event spatial accuracy is the accuracy with which the distance (in air) between two reflections can be measured, when both reflections are displayed in the same sweep. It does not include any error in the value of group refractive index which is entered by the user for measurements in various waveguide materials.

**Specification**

<b>Two-event Spatial Accuracy</b>	
1 to 9.99 mm span	±2% of span
10 to 400 mm span	±1% of span

**Specifications**

---

## Two-Event Spatial Resolution

**Description**

Two-event spatial resolution defines the physical spacing (in air) of two equal magnitude reflections such that the responses on the HP 8504B precision reflectometer have a 3 dB valley between them (averaging off).

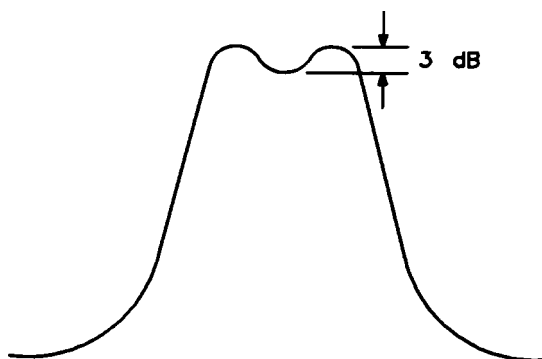

The HP 8504B is basically a scanning Michelson interferometer. The test port arm is made up entirely of non-dispersion shifted fiber, while the reference arm contains a fiber portion as well as the variable open-beam portion of the scanning mirror of the interferometer. This situation does not affect the resolution at 1300 nm. However at 1550 nm, it results in a differential dispersion between the two arms of the interferometer which is seen as a pulse broadening on the display of the HP 8504B Precision Reflectometer. This pulse broadening degrades the two-event resolution at 1550 nm, having minimal effect when the open-beam path in the reference arm of the interferometer is short (mirror near the start of its scan range), but increases as the open-beam path becomes longer.



**Specification**

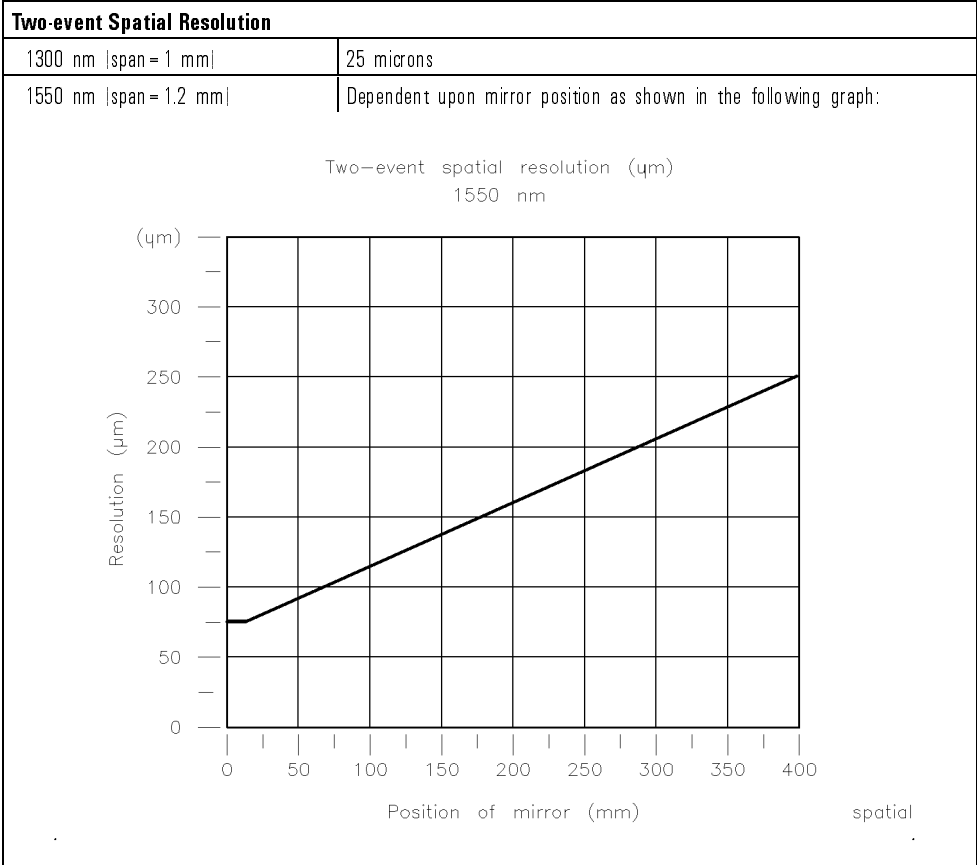

**Specifications**

---

## Spurious Responses

**Description**

Internal reflections within the instrument can cause spurious signals to be displayed along with the true signals. The level of the spurious signals depends on the magnitude of the reflections from the device being tested. For example, if a 15 dB reflection signal was measured using the 1550 nm source, all possible spurious signals would be lower than  $-77$  dB return loss ( $-15$  dB  $-62$  dB) in a range of  $\pm 20$  mm from the location of the  $-15$  dB reflection.

**Specification**

Spurious Responses <sup>1</sup>	Offset <sup>2</sup>			
	-20 to -10 mm	-10 to -0.5 mm	0.5 to 10 mm	10 to 20 mm
1300 nm source	-55 dB	-45 dB	-65 dB	-65 dB
1550 nm source	-62 dB	-62 dB	-62 dB	-62 dB

<sup>1</sup> Indicates responses below largest reflection. Specification applies with averaging on in minimum span.

<sup>2</sup> Offset of spurious response from displayed reflection.

**Specifications**

<b>Operating Specifications</b>	
Use	indoor
Operating temperature	10°C to +40°C
Non-operating, storage temperature	-40°C to +70°C
Altitude	up to 15,000 feet [4,572 meters]
Humidity	15% to 95%, non-condensing
Maximum relative humidity	80% for temperatures up to 31°C decreasing linearly to 50% relative humidity at 40°C.
Display Processor section:	
Power requirements	50/60 Hz [range: 47 — 66 Hz] 115/230 Vac ±10%
Power consumption	350 VA maximum
Lightwave section:	
Power requirements	50/60 Hz [range: 47 — 66 Hz] 110/120/220/240 Vac ±10%
Power consumption	200 VA maximum
<b>Physical Specifications</b>	
Weight	35 kg
Dimensions [H × W × D]	370 × 460 × 570 mm

# Characteristics

<b>Compatible fiber</b> <sup>1</sup>	<i>9/125 μm.</i>	
<b>Source Characteristics</b>	<b>1300 nm</b>	<b>1550 nm</b>
Peak Wavelength	<i>1308 ± 30 nm</i>	<i>1550 ± 30 nm</i>
Spectral Width <sup>2</sup>	<i>53 nm</i>	<i>55 nm</i>
Average Power <sup>3</sup>	<i>-17 dBm</i>	<i>-17 dBm</i>
<b>Measurement span</b> <sup>4</sup>	<i>1 to 400 mm.</i>	
<b>Sweep Speed (scan rate)</b>		
1300 nm source	<i>18 mm/sec (56 msec/mm)</i>	
1550 nm source	<i>21 mm/sec (47 msec/mm)</i>	

1 Useful measurements are achievable with other fiber types, but measurement performance may not be optimum.

2 Spectral width is at full width, half-maximum.

3 Average power levels are measured at the front-panel TEST PORT connector.

4 This is the equivalent distance in air, and can be offset by using fiber extension cables.

<b>Return Loss Uncertainty</b> <sup>1</sup>	
Polarization Sensitivity	<i>±0.75 dB</i>
Amplitude Flatness Versus Mirror Position	<i>±1.0 dB</i>
Dispersion Effects	<i>±0.3 dB</i>

1 All these items are independent, and their effects are combined using a root-sum-of-the-square method.

**Measurement Noise Floor**

The instrument measurement noise floor is nearly independent of mirror position when using the 1300 nm source.

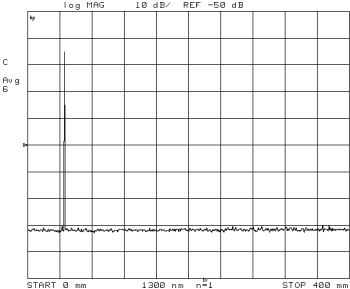

**Noise floor with 1300 nm source.**

For the 1550 nm source with dispersion correction enabled, the measurement noise floor depends on the mirror position. The noise floor at a mirror position of 400 mm is approximately 5 dB higher than at a mirror position of 0 mm. The noise floor for all mirror positions can be substantially lowered by narrowing the measurement span.

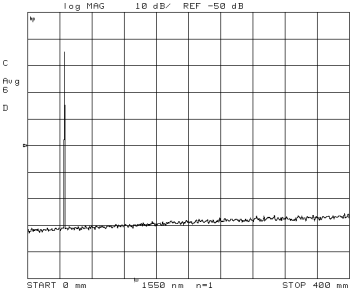

**Noise floor with 1550 nm source.**

---

## Regulatory Information

---

### Notice for Germany: Noise Declaration

L<sub>pA</sub> < 70 dB  
am Arbeitsplatz (operator position)  
normaler Betrieb (normal operation)  
nach DIN 45635 T. 19 (per ISO 7779)

<b>DECLARATION OF CONFORMITY</b> according to ISO/IEC Guide 22 and EN 45014		
<b>Manufacturer's Name:</b>	Hewlett-Packard Co.	
<b>Manufacturer's Address:</b>	1400 Fountaingrove Parkway Santa Rosa, California 95403 U.S.A.	
<b>Declares that the product:</b>		
Product Name:	Precision Reflectometer	
Model Numbers:	HP 8504B	
Product Options:	This declaration covers all options of the above products.	
<b>Conforms to the following product specifications:</b>		
Safety:	IEC 348:1978/HD 401:1980	
EMC:	CISPR 11:1990 /EN 55011:1991, Group 1 Class A IEC 801-2:1991 /EN 50082-1:1992, 4 kV CD, 8 kV AD IEC 801-3:1984 /EN 50082-1:1992, 3V/m, 27-500 MHz IEC 801-4:1988 /EN 50082-1:1992, 500 V signal, 1000 V AC	
<b>Supplementary Information:</b>		
The products herewith comply with the requirements of the Low Voltage Directive 73/23/EEC and the EMC Directive 89/336/EEC.		
Santa Rosa, California	<u>3/13/95</u>	
<b>Location</b>	<b>Date</b>	<b>Dixon Browder / Quality Manager</b>
<b>European Contact:</b>		
Your local Hewlett-Packard Sales and Service Office or Hewlett-Packard GmbH, Department ZQ/Standards Europe, Herrenberger Straße 130, D-71034 Boeblingen (FAX: + 49-7031-14-3143)		

## Specifications and Regulatory Information

---



---

## Error Messages

---

# Error Messages

This section lists the error messages that may be displayed or transmitted by the instrument over HP-IB. Each error message is accompanied by an explanation and suggestions to help solve the problem. Some messages are for information only, and do not indicate an error condition.

In addition to error messages, instrument status is indicated by status notations in the left margin of the display. Examples are "Avg" and "Hld". Sometimes these appear in conjunction with error messages.

**NOTE**

When displayed, error messages are usually preceded with the word "CAUTION:".

**Contents**

Message Definitions .....	7-3
Error Message Numbers .....	7-11

---

## Message Definitions

**ADDRESSED TO TALK WITH NOTHING TO SAY** An enter command was sent to the reflectometer without first requesting data with an appropriate output command (such as "OUTPDATA"). The reflectometer has no data in the output queue to satisfy the request.

HP-IB error number: 31

**AIR FLOW RESTRICTED: CHECK FAN FILTER** An inadequate air flow condition has been detected. Clean the fan filter. For most efficient cooling, the instrument covers should be in place. If the problem persists, troubleshoot the power supply.

HP-IB error number: 20

**ANOTHER SYSTEM CONTROLLER ON HP-IB** Selection of SYSTEM CONTROLLER under LOCAL could not be accomplished because another System Controller is already connected on HP-IB.

HP-IB error number: 37

**ASCII: MISSING 'CITIFILE' statement** In reading an ASCII file from disk, the reserved word "CITIFILE" was not found.

HP-IB error number: 104

**ASCII: MISSING 'VAR' statement** In reading an ASCII file from disk, the reserved word "VAR" was not found.

HP-IB error number: 105

**ASCII: MISSING 'DATA' statement** In reading an ASCII file from disk, the reserved word "DATA" was not found.

HP-IB error number: 106

**Message Definitions**

**ASCII: MISSING 'BEGIN' statement** In reading an ASCII file from disk, the reserved word "BEGIN" was not found.

HP-IB error number: 107

**BLOCK INPUT ERROR** The reflectometer did not receive a complete data transmission. This is usually caused by an interruption of the bus transaction. Clear by pressing the LOCAL key or aborting the IO process at the controller.

HP-IB error number: 34

**BLOCK INPUT LENGTH ERROR** The length of the header received by the reflectometer did not agree with the size of the internal array block. Refer to the HP-IB Programming Guide for instructions on using input commands.

HP-IB error number: 35

**CHANGE HP-IB to SYST CTRL or PASS CTRL** A command (front panel or HP-IB) has been received that requests the reflectometer to take control of the HP-IB, but it is in TALKER/LISTENER mode. Change selection under LOCAL.

HP-IB error number: 36

**CORRECTION CONSTANTS NOT STORED** The results of a service adjustment have not been stored in the reflectometer.

HP-IB error number: 3

**DISK HARDWARE PROBLEM** The disk drive is properly connected, but has returned a service related error message when accessed.

HP-IB error number: 39

**DISK IS WRITE PROTECTED** The write-protect feature on a disk has been enabled.

HP-IB error number: 48

**DISK MEDIUM NOT INITIALIZED** The floppy disk must be initialized in order to store files. Perform an initialization ( INITIALIZE DISK under SAVE, STORE TO DISK, DEFINE, INIT, PURGE)

HP-IB error number: 40

**DISK MESSAGE LENGTH ERROR** The number of bytes transferred to or from the disk is inconsistent with the number specified in the previously sent disk command.

HP-IB error number: 19

**DISK WEAR-REPLACE DISK SOON** The floppy disk surface is wearing out; replace with a new disk to prevent data loss.

HP-IB error number: 49

**DISK: not on, not connected, wrong addr**s The disk drive does not respond to control. Verify power to the disk drive, and check the HP-IB connection between the reflectometer and the disk drive. Ensure that the disk address recognized by the reflectometer matches the HP-IB address set on the disk drive itself.

HP-IB error number: 38

**FIRST CHARACTER MUST BE A LETTER** When titling a register or file, the first character must be a letter. Rename the register/file appropriately.

HP-IB error number: 42

**FUNCTION NOT VALID** The requested function is incompatible with the current instrument state.

HP-IB error number: 14

**ILLEGAL UNIT OR VOLUME NUMBER** The disk unit or volume number set in the reflectometer is not valid. Refer to the disk drive operating manual.

HP-IB error number: 46

**Message Definitions**

**INITIALIZATION FAILED** Disk initialization failed, usually due to a damaged disk.

HP-IB error number: 47

**INPUT ATTEMPTED WITHOUT SELECTING INPUT TYPE** An “INPU” command has not been received, but an attempt to transfer data occurred.

HP-IB error number: 32

**INSTRUMENT STATE MEMORY CLEARED** The five instrument state registers have been cleared from memory.

HP-IB error number: 56

**INSUFFICIENT MEMORY** The last front panel or HP-IB request could not be implemented due to insufficient memory space. See section 6.9, “Save and Recall.”

HP-IB error number: 51

**INVALID KEY** An undefined softkey was pressed.

HP-IB error number: 2

**MOTOR COMMAND ERROR** The motor controller has received an invalid command.

HP-IB error number: 101

**MOTOR RESET FAILED** Motor control failed to reset. Check power cord and interconnect cable.

HP-IB error number: 99

**MOTOR STOPPED--EXCESSIVE POSITION ERROR** Motor controller is unable to control position within acceptable limits. Press the PRESET key. If error persists contact your Hewlett-Packard Service Center.

HP-IB error number: 95

**MOTOR STOPPED--NEGATIVE LIMIT** Negative position limit exceeded. Press the PRESET key. If error persists contact your Hewlett-Packard Service Center.

HP-IB error number: 97

**MOTOR STOPPED--POSITIVE LIMIT** Positive position limit exceeded. Press the PRESET key. If error persists contact your Hewlett-Packard Service Center.

HP-IB error number: 96

**MOTOR TRAJECTORY ERROR** Initialization of motor position failed. Press the PRESET key. If error persists contact your Hewlett-Packard Service Center.

HP-IB error number: 100

**NO DISK MEDIUM IN DRIVE** No disk was found in the current disk unit. Insert a disk, or check the disk unit number stored in the reflectometer.

HP-IB error number: 41

**NO FILE(S) FOUND ON DISK** No files of the type created by the reflectometer store operation were found on the disk.

HP-IB error number: 45

**NO MARKER DELTA - SPAN NOT SET** The MARKER D -> SPAN softkey function requires that delta marker mode be turned on, with at least two markers displayed.

HP-IB error number: 15

**NO SIGNAL - CHECK BNC CABLE ON REAR PANEL** The signal level at the display processor rear panel AUX INPUT BNC connector is not at the expected value. This may be due to a faulty BNC cable connection between the display processor and the lightwave section.

HP-IB error number: 109

**Message Definitions**

**NO SOURCE FOUND - CHECK POWER TO TEST SET** AC mains power is not reaching the lightwave section, or the reflectometer has no installed source.

HP-IB error number: 103

**NO VALID MEMORY TRACE** A request to display a memory or trace math operation has occurred, but a data trace has not been previously stored in memory. (See DATA -> MEMORY under DISPLAY .)

HP-IB error number: 54

**NO VALID STATE IN REGISTER** A request to recall an internal register has occurred, but an instrument state has not been previously saved. (See SAVE)

HP-IB error number: 55

**NOT ENOUGH SPACE ON DISK FOR STORE** The disk is full; purge files or replace with another disk.

HP-IB error number: 44

**ONLY LETTERS AND NUMBERS ARE ALLOWED** When titling a register or file, only alphanumeric characters are allowed. Rename the register/file appropriately.

HP-IB error number: 43

**OPTIONAL FUNCTION; NOT INSTALLED** An attempt has been made to use an optional function for which that option has not been installed.

HP-IB error number: 1

**PLOTTER: not on, not connected, wrong addr**s The plotter does not respond to control. Verify power to the plotter, and check the HP-IB connection between the reflectometer and the plotter. Ensure that the plotter address recognized by the reflectometer matches the HP-IB address set on the plotter itself.

HP-IB error number: 26



**PLOTTER NOT READY-PINCH WHEELS UP** The plotter is not ready to plot; the paper has not been properly inserted or loaded.

HP-IB error number: 28

**POWER SUPPLY HOT!** The power supply temperature has been sensed by the post regulator test or during self test. Turn off the reflectometer immediately, and contact your Hewlett-Packard Service Center.

HP-IB error number: 21

**PRINTER: not on, not connected, wrong addr**s The printer does not respond to control. Verify power to the printer, and check the HP-IB connection between the reflectometer and the printer. Ensure that the printer address recognized by the reflectometer matches the HP-IB address set on the printer itself.

HP-IB error number: 24

**REQUESTED DATA NOT CURRENTLY AVAILABLE** The reflectometer does not currently contain the data being requested. For example, this condition occurs when error term arrays are requested and no calibration is active.

HP-IB error number: 30

**SOURCE 1 TEMPERATURE LOOP OPEN** The temperature loop on the 1300 nm source is open. Turn off the reflectometer immediately, and contact your Hewlett-Packard Service Center.

HP-IB error number: 93

**SOURCE 2 TEMPERATURE LOOP OPEN** The temperature loop on the 1550 nm source is open. Turn off the reflectometer immediately, and contact your Hewlett-Packard Service Center.

HP-IB error number: 94

**Message Definitions**

**SYNTAX ERROR** An improperly formatted or misspelled command was received over HP-IB.

HP-IB error number: 33

**SYSTEM IS NOT IN REMOTE** The reflectometer is in local mode. In this mode, it will not respond to HP-IB commands with front panel key equivalents. It will, however, respond to commands that have no such equivalents, such as status requests.

HP-IB error number: 52

**test cannot execute when source is off** An attempt is being made to run the receiver gain adjust test with the source off.

HP-IB error number: 108

**TEST PORT OVERLOAD, REDUCE POWER**

HP-IB error number:

**TEST SET NOT FOUND - CHECK I/O CABLE** The reflectometer lightwave section (test set) is not correctly connected to the display processor. Check the ac line cord and the interconnect cable for proper connections.

HP-IB error number: 102

---

## Error Message Numbers

<b>Number</b>	<b>Error Message</b>
1	OPTIONAL FUNCTION; NOT INSTALLED
2	INVALID KEY
3	CORRECTION CONSTANTS NOT STORED
14	FUNCTION NOT VALID
15	NO MARKER DELTA - SPAN NOT SET
19	DISK MESSAGE LENGTH ERROR
20	AIR FLOW RESTRICTED: CHECK FAN FILTER
21	POWER SUPPLY HOT!
24	PRINTER: not on, not connected, wrong addr
26	PLOTTER: not on, not connected, wrong addr
28	PLOTTER NOT READY - PINCH WHEELS UP
30	REQUESTED DATA NOT CURRENTLY AVAILABLE
31	ADDRESSED TO TALK WITH NOTHING TO SAY
32	INPUT ATTEMPTED WITHOUT SELECTING INPUT TYPE
33	SYNTAX ERROR
34	BLOCK INPUT ERROR
35	BLOCK INPUT LENGTH ERROR
36	CHANGE HP-IB TO SYST CTRL or PASS CTRL
37	ANOTHER SYSTEM CONTROLLER ON HP-IB
38	DISK: not on, not connected, wrong addr
39	DISK HARDWARE PROBLEM
40	DISK MEDIUM NOT INITIALIZED
41	NO DISK MEDIUM IN DRIVE
42	FIRST CHARACTER MUST BE A LETTER

## Error Messages

<b>Number</b>	<b>Error Message</b>
43	ONLY LETTERS AND NUMBERS ARE ALLOWED
44	NOT ENOUGH SPACE ON DISK FOR STORE
45	NO FILE(S) FOUND ON DISK
46	ILLEGAL UNIT OR VOLUME NUMBER
47	INITIALIZATION FAILED
48	DISK IS WRITE PROTECTED
49	DISK WEAR-REPLACE DISK SOON
51	INSUFFICIENT MEMORY
52	SYSTEM IS NOT IN REMOTE
54	NO VALID MEMORY TRACE
55	NO VALID STATE IN REGISTER
56	INSTRUMENT STATE MEMORY CLEARED
93	SOURCE 1 TEMPERATURE LOOP OPEN
94	SOURCE 2 TEMPERATURE LOOP OPEN
95	MOTOR STOPPED - EXCESSIVE POSITION ERROR
96	MOTOR STOPPED - POSITIVE LIMIT
97	MOTOR STOPPED - NEGATIVE LIMIT
99	MOTOR RESET FAILED
100	MOTOR TRAJECTORY ERROR
101	MOTOR COMMAND ERROR
102	CHECK I/O CABLE
103	NO SOURCE FOUND - CHECK POWER TO TEST SET
104	ASCII: MISSING 'CITIFILE' statement
105	ASCII: MISSING 'VAR' statement
106	ASCII: MISSING 'DATA' statement
107	ASCII: MISSING 'BEGIN' statement
108	TEST CANNOT EXECUTE WHEN SOURCE IS OFF
109	NO SIGNAL - CHECK BNC CABLE ON REAR PANEL

---

---

Index

---

# Index

## Special characters

- 1 1300 nm softkey, 3-6, 4-49, 5-12
- 1550 nm softkey, 3-6, 4-49, 5-12
- 1550 nm source, chromatic dispersion, 2-22
  
- A abort a print or plot, 3-50
- accessories, 1-4
- accessory kit, 1-4
- accuracy
  - dynamic, 2-21
  - low-level reflections, 2-21
- adapter
  - part number, 5-55
- adapters, front-panel, 5-54
- ADDRCONT command, 4-16
- ADDRDISK command, 4-16
- ADDRESS CONTROLLER softkey, 4-16, 4-42, 5-12
- ADDRESS DISK softkey, 4-16, 5-12
- ADDRESSED TO TALK WITH NOTHING TO SAY error message, 7-3
- addresses, HP-IB, 4-4
- ADDRESS HP8504 softkey, 5-12
- ADDRESS PLOTTER softkey, 4-16, 5-12
- ADDRESS PRINTER softkey, 4-17, 5-13
- ADDRPLOT command, 4-16
- ADDRPRIN command, 4-16
- ADD softkey, 4-47, 5-12
- ADJUST DISPLAY softkey, 5-13
- AIR FLOW RESTRICTED CHECK FAN FILTER error message, 7-3
- ALL MKR OFF softkey, 4-37
- all OFF softkey, 5-13
- AMPLITUDE OFFSET softkey, 3-22, 4-32, 5-13
- annotation, 3-45
- ANOTHER SYSTEM CONTROLLER ON HP-IB error message, 7-3
- ASCII MISSING error message, 7-3, 7-4
- ASCII softkey, 5-13
- assistance, xi
- audible warnings, 3-45
- AUTO command, 4-17
- AUTO FF ON off softkey, 5-14

- AUTO SCALE softkey, 3-7, 4-17, 5-14
- autotransformer, 1-2
- AUX INPUT connector, 5-14
- AVERAGING FACTOR softkey, 3-11, 4-17, 5-14
- AVERAGING on OFF softkey, 3-11, 4-17, 5-14
- AVERAGING RESTART softkey, 3-11, 4-17, 5-14
- averaging traces, 3-9
- AVERFACT command, 4-17
- AVERO command, 4-17
- AVERREST command, 4-17
- AVG key, 5-14
  - menu map, 5-3
- Avg status notation, vii, 5-14

**B**

- BACI command, 4-17
- BACKGROUND INTENSITY softkey, 4-18, 5-15
- BACK SPACE softkey, 5-15
- balance internal receiver, 2-20
- BALANCE RECEIVER softkey, 4-18, 5-15
- BALD command, 4-18
- BALE command, 4-18
- BALR command, 4-18
- beep, 3-45
  - turning off, 3-46
- BEEPDONE command, 4-18
- BEEP DONE on off softkey, 4-18
- BEEP DONE ON off softkey, 3-46, 5-15
- BEEPFAIL command, 4-18
- BEEP FAIL on off softkey, 4-18
- BEEP FAIL on OFF softkey, 5-15
- beep, to turn off, 5-15, 5-16
- BEEPWARN command, 4-18
- BEEP WARN on off softkey, 4-18
- BEEP WARN on OFF softkey, 3-45, 5-16
- Biconic adapter, 5-54
- BINARY softkey, 5-25
- block diagram, 5-53
- BLOCK INPUT ERROR error message, 7-4
- BLOCK INPUT LENGTH ERROR error message, 7-4
- BLUE connector, 5-16
- BNC cable
  - part number, 5-55
- BRIGHTNESS softkey, 4-19, 5-16

- C cabinet
  - cleaning, 1-2
  - temperature, 1-2
- cables
  - calibration, 2-4
  - lengths, 2-7
  - line-power, 5-57
  - rear panel, 1-11
- cable tray, 2-29
  - part number, 5-55
- CALD command, 4-19
- CALE command, 4-19
- CALFRES command, 4-19
- CALIBRATE MAGNITUDE softkey, 4-19, 5-16
- CALIBRATE MENU softkey, 5-16
- calibration
  - and span, 2-5
  - manual, 2-20
  - standard, 2-16
  - standards, 2-20
  - turning off, 2-28, 5-18
- CALIBRATION REQUIRED error message, 5-18
- CAL key, 5-16
  - menu map, 5-3
- CALM command, 4-19
- CALUSER command, 4-19
- CAUTION error message
  - CALIBRATION REQUIRED, 5-18
- CAUTION messages
  - ADDRESSED TO TALK WITH NOTHING TO SAY, 7-3
  - AIR FLOW RESTRICTED CHECK FAN FILTER, 7-3
  - ANOTHER SYSTEM CONTROLLER ON HP-IB, 7-3
  - ASCII MISSING , 7-3
  - BLOCK INPUT ERROR, 7-4
  - BLOCK INPUT LENGTH ERROR, 7-4
  - CHANGE HP-IB to SYST CTRL or PASS CTRL, 7-4
  - CORRECTION CONSTANTS NOT STORED, 7-4
  - DISK HARDWARE PROBLEM, 7-4
  - DISK IS WRITE PROTECTED, 7-4
  - DISK MEDIUM NOT INITIALIZED, 7-5
  - DISK MESSAGE LENGTH ERROR, 7-5
  - DISK not on, not connected, wrong addrs, 7-5
  - DISK WEAR-REPLACE DISK SOON, 7-5
  - FIRST CHARACTER MUST BE A LETTER, 7-5
  - FUNCTION NOT VALID, 7-5
  - ILLEGAL UNIT OR VOLUME NUMBER, 7-5
  - INITIALIZATION FAILED, 7-6
  - INPUT ATTEMPTED WITHOUT SELECTING INPUT TYPE, 7-6
  - INSTRUMENT STATE MEMORY CLEARED, 7-6



INSUFFICIENT MEMORY, 7-6  
 INVALID KEY, 7-6  
 MOTOR COMMAND ERROR, 7-6  
 MOTOR RESET FAILED, 7-6  
 MOTOR STOPPED—EXCESSIVE POSITION ERROR, 7-6  
 MOTOR STOPPED—NEGATIVE LIMIT, 7-7  
 MOTOR STOPPED—POSITIVE LIMIT, 7-7  
 MOTOR TRAJECTORY ERROR, 7-7  
 NO DISK MEDIUM IN DRIVE, 7-7  
 NO FILE(S) FOUND ON DISK, 7-7  
 NO MARKER DELTA - SPAN NOT SET, 7-7  
 NO SIGNAL - CHECK BNC CABLE ON REAR PANEL, 7-7  
 NO SOURCE FOUND - CHECK POWER TO TEST SET, 7-8  
 NOT ENOUGH SPACE ON DISK FOR STORE, 7-8  
 NO VALID MEMORY TRACE, 7-8  
 NO VALID STATE IN REGISTER, 7-8  
 ONLY LETTERS AND NUMBERS ARE ALLOWED, 7-8  
 OPTIONAL FUNCTION; NOT INSTALLED, 7-8  
 PLOTTER not on, not connected, wrong addr, 7-8  
 PLOTTER NOT READY-PINCH WHEELS UP, 7-9  
 POWER SUPPLY HOT!, 7-9  
 PRINTER not on, not connected, wrong addr, 7-9  
 REQUESTED DATA NOT CURRENTLY AVAILABLE, 7-9  
 SOURCE 1 TEMPERATURE LOOP OPEN, 7-9  
 SOURCE 2 TEMPERATURE LOOP OPEN, 7-9  
 SYNTAX ERROR, 7-10  
 SYSTEM IS NOT IN REMOTE, 7-10  
   test cannot execute when source is off, 7-10  
   TEST PORT OVERLOAD, REDUCE POWER, 7-10  
   TEST SET NOT FOUND - CHECK I/O CABLE, 7-10  
 CAUTION messages ASCII MISSING , 7-4  
 CBRI command, 4-19  
 CENT command, 4-20  
 CENTER key, 5-17  
 CENTER softkey, 4-20  
 certification, xi  
 CHANGE HP-IB to SYST CTRL or PASS CTRL error message, 7-4  
 characteristics, 6-14  
 chromatic dispersion, 2-22, 2-28  
 CITIfile, 3-41  
 CLEA command, 4-20  
 cleaning  
   adapter, 1-25  
   cabinet, 1-2  
   non-lensed connectors, 1-24  
 cleaning fiber-optic connections, 1-22, 1-24  
 CLEARALL command, 4-20  
 CLEAR ALL softkey, 4-20, 5-17  
 CLEAR REG1-5 softkey, 4-20

- CLEAR REG1 softkey, 5-17
- CLEAR REG2 softkey, 5-17
- CLEAR REG3 softkey, 5-17
- CLEAR REG4 softkey, 5-17
- CLEAR REG5 softkey, 5-17
- CLEAR REGISTER softkey, 5-17
- CLES command, 4-20
- \*CLS, 4-9
  - command, 4-13
- CLS command, 4-20
- COLO command, 4-20
- COLOR command, 4-21
- colors, changing, 3-45
- COLOR softkey, 4-21, 4-44, 5-17
- command
  - common , 4-12
  - names, 4-7
  - queries, 4-6
  - versus keys, 4-54
- computer
  - address, 4-4
- CONFIGURE PLOT softkey, 5-17
- connector care, 1-22
- CONT command, 4-21
- CONTINUOUS softkey, 4-21, 5-17
- COPYFRFT command, 4-21
- COPY FROM FILE TITLE softkey, 4-21, 5-18
- COPY FROM REG TITLES softkey, 4-21, 5-18
- COPYFRRT command, 4-21
- COPY key, 5-18
  - menu map, 5-4
- CORR command, 4-21
- correction, 5-18
  - data, 2-22
- CORRECTION CONSTANTS NOT STORED error message, 7-4
- CORRECTION on OFF softkey, 4-21, 5-18
- cotton swabs, part number, 5-55
- C status notation, vii, 5-16

**D** D4 adapter, 5-54

- DATA and MEMORY softkey, 4-24, 5-19
- DATA ARRAY on OFF softkey, 4-25, 4-26, 5-19
- DATA LIMIT LN softkey, 5-19
- DATA → MEMORY 1 softkey, 3-35, 5-19
- DATA → MEM softkey, 4-22
- data trace, 3-13, 3-34, 3-45
- DATI command, 4-22
- DEBU command, 4-22

- debugging programs, 4-5
- DEFAULT COLORS softkey, 4-22, 5-19
- default plotting values , 5-20
- DEFAULT SETUP softkey, 4-23
- DEFAULT SETUPS softkey, 5-20
- DEFC command, 4-22
- DEFINE PEAK softkey, 3-17, 5-20
- DEFINE PLOT softkey, 4-43, 5-20
- DEFINE STORE softkey, 5-20
- delay line, 5-52
- DELETE softkey, 4-48, 5-20
- DELO command, 4-22
- DELR command, 4-22
- DELRFIXM command, 4-22
- DELTA LIMITS softkey, 4-31, 5-21
- delta markers , 3-12
- DFLT command, 4-23
- Diamond HMS-10/HP adapter, 5-54
- DIN 47256 adapter, 5-54
- disk
  - address, 4-4
  - drive, 3-40
  - format, 3-40, 3-41, 3-43
- DISK FILE FORMAT softkey, 4-47, 5-21
- DISK HARDWARE PROBLEM error message, 7-4
- DISK IS WRITE PROTECTED error message, 7-4
- DISK MEDIUM NOT INITIALIZED error message, 7-5
- DISK MESSAGE LENGTH ERROR error message, 7-5
- DISK not on, not connected, wrong addr error message, 7-5
- DISKUNIT command, 4-23
- DISK UNIT NUMBER softkey, 4-23, 5-21
- DISKVOLU command, 4-23
- DISK WEAR-REPLACE DISK SOON error message, 7-5
- DISM command, 4-23
- DISPCOR command, 4-23
- DISPDATA command, 4-23
- DISPDATM command, 4-24
- DISPER COR on OFF softkey, 5-21
- DISPER COR softkey, 4-23
- dispersion, chromatic, 2-22
- display
  - printing and plotting, 3-47
- DISPLAY DATA softkey, 4-23, 5-22
- displayed noise, 3-9
- DISPLAY key, 5-22
  - menu map, 5-5
- DISPMEMO command, 4-24
- DISP MKRS ON off softkey, 4-23
- DISTANCE softkey, 3-7

- DIST command, 4-24
- DONE softkey, 4-18, 4-48
- DOWN command, 4-24
- D status notation, vii, 5-19
- dynamic accuracy, 2-21

**E**

- EDIT LIMIT LINE softkey, 4-24, 5-22
- EDITLIML command, 4-24
- EDIT softkey, 4-48, 5-22
- electrostatic discharge, iii
- ENTO command, 4-24
- ENTRY OFF key, 5-22
- ERASE TITLE softkey, 5-22
- error
  - messages, 7-2
- error messages
  - numbers, 7-11
- ESB? command, 4-24
- \*ESE command, 4-13
- ESE command, 4-25
- ESNB command, 4-25
- \*ESR? command, 4-9, 4-13
- ESR? command, 4-25
- event status register, 4-9, 4-10
- excursion, peak, 3-14
- EXIT softkey, 4-18, 4-19
- EXT AM connector, 5-23
- EXTERNAL softkey, 2-22, 3-6, 4-49, 5-23
- external source, 2-22, 3-6
- EXTMDATA command, 4-25
- EXTMFORM command, 4-25
- EXTMGRAP command, 4-25
- EXTMRAW command, 4-26
- EXT REF IN connector, 5-23
- ext status notation, vii, 5-23
- EXTT command, 4-26
- EXT TRIGGER connector, 5-23
- EXT TRIG on OFF softkey, 5-23

**F**

- fail annotation, 3-20
- FC/PC
  - adapter, 5-54
  - bare fiber adapter, 5-54
  - cable part numbers, 5-55
- fiber, iv
- fiber-optic cables
  - cleaning connections, 1-22
  - inspecting, 1-23

- FIRMWARE REVISION softkey, 5-24
- FIRST CHARACTER MUST BE A LETTER error message, 7-5
- fixed marker, 3-13
- FIXED MKR MENU softkey, 5-24
- FIXED MKR POSITION softkey, 4-36, 5-24
- FIXED MKR VALUE softkey, 4-36, 5-24
- FL annotation, 3-21
- FLAT LINE softkey, 5-24
- FORM1 command, 4-26
- FORM2 command, 4-26
- FORM3 command, 4-26
- FORM4 command, 4-26
- FORM5 command, 4-26
- FORMAT ARY on OFF softkey, 4-25, 5-25
- FORMAT BINARY softkey, 5-25
- FORMAT key, 3-7, 5-25
  - menu map, 5-5
- FRESNEL (3.16%) softkey, 5-25
- FRESNEL (3.37%) softkey, 5-25
- front panel
  - adapters, 5-54
  - connectors, vi
- FULL PAGE softkey, 4-27, 5-26
- FULL softkey, 5-44
- FULL SPAN softkey, 3-5, 4-27, 5-26
- FULP command, 4-27
- FULS command, 4-27
- FUNCTION NOT VALID error message, 7-5
- fuse
  - replacing, 1-20

**G** GRAPHICS on OFF softkey, 4-25, 5-26

- graticule, 3-45
- GRATICULE TEXT softkey, 5-26
- GREEN connector, 5-26
- GROI command, 4-27
- GUIC command, 4-27
- guided calibration, vi, 2-6
- GUIDED CAL softkey, 1-14, 2-18, 4-27, 5-27
- guided setup, vi
  - non- pigtailed device, 2-13
  - pigtailed device, 2-7
- guided setups, 2-6
- GUIDED SETUP softkey, 5-27
- GUIS command, 4-27

- H** hard-copy results, 3-47
  - Hld status notation, vii, 5-27
  - HOLD command, 4-27
  - HORIZ
    - DISTANCE softkey, 5-27
  - HORIZ. DISTANCE softkey, 4-24
  - horizontal axis, 5-27
  - horizontal scale, 3-5
  - HP-IB
    - addresses, 4-4
    - connector, 5-27
    - modes, 4-4
    - status, 4-2
  - HP-IB DIAG on OFF softkey, 4-5, 4-22, 5-27
  
- I** \*IDN? command, 4-13
  - IDN? command, 4-28
  - IEC Class, iii
  - IEEE 488.2 common commands, 4-12
  - ILLEGAL UNIT OR VOLUME NUMBER error message, 7-5
  - IME softkey, 4-51
  - INDEREFR command, 4-28
  - index-matching compounds, 1-22
  - index matching gel, 1-22
  - INID command, 4-28
  - INIT DISK? YES softkey, 5-28
  - INITIALIZATION FAILED error message, 7-6
  - INITIALIZE DISK softkey, 4-28, 5-28
  - INPUDATA command, 4-28
  - INPUFORM command, 4-28
  - INPULEAS command, 4-29
  - INPURAW1 command, 4-29
  - INPUT ATTEMPTED WITHOUT SELECTING INPUT TYPE error message, 7-6
  - input connector, 1-22, 5-43
  - inspecting
    - cables, 1-23
    - shipment, 1-4
  - instrument
    - sections, 1-6
  - instrument options, 5-56
  - INSTRUMENT STATE MEMORY CLEARED error message, 7-6
  - instrument states
    - saving to file, 3-40
    - saving to registers, 3-36
  - INSUFFICIENT MEMORY error message, 7-6
  - INTE command, 4-29
  - INTENSITY softkey, 4-29, 5-28
  - internal registers, 3-36

- INVALID KEY error message, 7-6
- IO INTERCONNECT cable
  - part number, 5-55
- I/O INTERCONNECT connector, 5-28

**K** key codes , 4-30  
KEY command, 4-30  
KOR? command, 4-31

**L** LaserJet, 3-47  
learn string, 3-36  
LED Classification, 6-4  
LEFL command, 4-31  
LEFT LOWER softkey, 4-31, 5-28  
LEFT UPPER softkey, 4-31, 5-29  
LEFU command, 4-31  
LIMD command, 4-31  
LIMIAMPO command, 4-31  
LIMILINE command, 4-32  
LIMIMAOF command, 4-32  
LIMIPOSO command, 4-32  
LIMITEST command, 4-32  
LIMIT LINE OFFSETS softkey, 5-29  
LIMIT LINE on off softkey, 4-32  
LIMIT LINE on OFF softkey, 3-23, 5-29  
limit lines, 3-19

- beep on failures, 5-15
- entering, 3-23
- pass/fail, 3-22, 3-24
- segment types, 3-21
- tutorial, 3-25

LIMIT MENU softkey, 3-19, 5-29  
LIMIT TEST on off softkey, 4-32  
LIMIT TEST on OFF softkey, 3-24, 5-29  
LIMIT TYPE softkey, 4-33, 5-29  
LIML command, 4-32  
LIMM command, 4-33  
LIMP command, 4-33  
LIMT command, 4-33  
LIMU command, 4-33  
line

- power cables, 5-57
- voltage, 1-8

line fuse

- replacing, 1-20

LINE TYPE DATA softkey, 5-30  
LINE TYPE MEMORY softkey, 4-34, 5-30  
LIN MAG softkey, 3-7, 4-34, 5-29

- LINM command, 4-34
- LINT command, 4-34
- LIST VALUES softkey, 3-49, 4-34, 5-30
- LISV command, 4-34
- LOAD command, 4-34
- LOAD FILE1 softkey, 5-30
- LOAD FILE2 softkey, 5-30
- LOAD FILE3 softkey, 5-30
- LOAD FILE4 softkey, 5-30
- LOAD FILE5 softkey, 5-30
- LOAD FROM DISK softkey, 4-34, 5-31
- LOCAL key, 4-2, 5-30
  - menu map, 5-6
- LOG MAG softkey, 4-34
- LOGM command, 4-34
- LOWER LIMIT softkey, 4-32, 5-31
- low-level reflections, 2-21
- low-reflection termination, 2-3
  - part number, 5-55
- LRN command, 4-35

**M**

- magnitude calibration, 2-20
- MARKBUCK command, 4-35
- MARKCENT command, 4-35
- MARK command, 4-35
- MARKER 1 softkey, 5-33
- MARKER 2 softkey, 5-33
- MARKER 3 softkey, 5-32, 5-33
- MARKER 4 softkey, 4-35, 5-33
- MARKER → AMP.OFF. softkey, 3-22
- MARKER → AMP. OFS. softkey, 5-32
- MARKER → AMP. OFS softkey, 4-32
- MARKER → CENTER softkey, 4-35, 5-31
- MARKER → FIXED MKR softkey, 4-35, 4-38, 5-31
- MARKER →MIDDLE softkey, 5-32
- MARKER → POSITION , 4-37
- MARKER → POSITION softkey, 4-37
- MARKER →POSITION softkey, 5-32
- MARKER → REFERENCE softkey, 4-37, 5-32
- MARKER → START softkey, 4-38, 5-32
- MARKER → STOP softkey, 4-38, 5-32
- markers, 3-12
  - delta, 3-13
  - fixed, 3-13
  - memory trace, 3-13
  - turning off, 3-18
- MARKER Δ → SPAN softkey, 4-38, 5-33
- MARKER Δ START softkey, 3-16



- MARKER  $\Delta$  STOP softkey, 3-16
- MARKFIXM command, 4-35
- MARKFPOS command, 4-36
- MARKFVAL command, 4-36
- MARKMAXI command, 4-36
- MARKMIDD command, 4-36
- MARKOFF command, 4-37
- MARKP command, 4-37
- MARKPOSI command, 4-37
- MARKPTRA command, 4-37
- MARKREF command, 4-37
- MARKSPAN command, 4-38
- MARKSTAR command, 4-38
- MARKSTOP command, 4-38
- MARKZERO command, 4-38
- MARKZOOM command, 4-38
- MAXS command, 4-38
- MAX SEARCH softkey, 3-7, 4-36, 4-38, 5-33
- MEAR command, 4-39
- MEAS key, 5-33
  - menu map, 5-8
- MEASSTAN command, 4-39
- measurement
  - lists of data values, 3-49
  - setting range, 3-4
  - units, 3-7
- measurement noise floor, 6-15
- MEASURE RESTART softkey, 3-6, 4-39, 4-46, 5-34
- MEASURE STANDARD softkey, 4-19, 4-39, 5-34
- MEMO command, 4-39
- memory 1, 3-34
- MEMORY 1 softkey, 5-34
- memory 2, 3-34
- MEMORY 2 REF LINE softkey, 5-35
- MEMORY 2 softkey, 4-39, 5-34
- MEMORY softkey, 4-24, 5-34
- memory trace, 3-13, 3-37, 3-45
- MENU command, 4-39
- MENU key, 2-26, 3-6, 5-35
  - menu map, 5-9
- MENUOFF command, 4-39
- MENUON command, 4-39
- MIDDLE VALUE softkey, 4-33, 4-36, 5-35
- MKR FCTN key, 3-13, 3-17, 5-35
  - menu map, 5-9
- MKR key, 5-35
  - menu map, 5-9
- MKR VALUE ON off softkey, 5-35
- MKR ZOOM softkey, 3-7, 5-35

MODIFY COLORS softkey, 5-36  
MOTOR COMMAND ERROR error message, 7-6  
MOTOR RESET FAILED error message, 7-6  
MOTOR STOPPED—EXCESSIVE POSITION ERROR error message, 7-6  
MOTOR STOPPED—NEGATIVE LIMIT error message, 7-7  
MOTOR STOPPED—POSITIVE LIMIT error message, 7-7  
MOTOR TRAJECTORY ERROR error message, 7-7  
MRK key, 3-13

- N** n, 3-5, 5-43, 5-49  
∇ symbol, 3-12  
NEXP command, 4-39  
NEXT PAGE softkey, 4-39  
NEXT PEAK HIGHER softkey, 5-36  
NEXT PEAK LEFT softkey, 5-36  
NEXT PEAK LOWER softkey, 5-36  
NEXT PEAK RIGHT softkey, 4-37, 5-36  
NO DISK MEDIUM IN DRIVE error message, 7-7  
NO FILE(S) FOUND ON DISK error message, 7-7  
noise, reducing, 3-9  
NO MARKER DELTA - SPAN NOT SET error message, 7-7  
NOOP command, 4-40  
NO SIGNAL - CHECK BNC CABLE ON REAR PANEL error message, 7-7  
NO SOURCE FOUND - CHECK POWER TO TEST SET error message, 7-8  
NOT ENOUGH SPACE ON DISK FOR STORE error message, 7-8  
notice for germany, noise declaration, 6-16  
NO VALID MEMORY TRACE error message, 7-8  
NO VALID STATE IN REGISTER error message, 7-8  
NUMG command, 4-40
- O** offices, sales and service, 1-30  
ONLY LETTERS AND NUMBERS ARE ALLOWED error message, 7-8  
\*OPC command, 4-13  
OPC command, 4-40  
OPEP command, 4-40  
operating parameters, lists of, 3-49  
OPERATING PARAMETERS softkey, 4-40  
operation verification, 1-12  
OP PARS (MKRS etc) softkey, 3-49, 5-36  
Option 001 accessory kit, 1-4  
OPTIONAL FUNCTION; NOT INSTALLED error message, 7-8  
options, 5-56  
OUTPACTI command, 4-40  
OUTPDATA command, 4-40  
OUTPERRO command, 4-40  
OUTPFORM command, 4-41  
OUTPIDEN command, 4-41  
OUTPKEY command, 4-41

- OUTPLEAS command, 4-41
- OUTPLIMF command, 4-41
- OUTPLML command, 4-41
- OUTPLMM command, 4-41
- OUTPMARK command, 4-42
- OUTPMEMO command, 4-42
- OUTPPLOT command, 4-42
- OUTPPRIN command, 4-42
- OUTPRAW1 command, 4-42
- OUTPTITL command, 4-42
- output connector, 5-42, 5-49
- OUTPUT (TO AUX INPUT) connector, 5-36
- OVL status notation, vii, 5-37

**P** packaging materials, 1-27

- PaintJet, 3-47
- part numbers, 5-55
- pass annotation, 3-20
- pass control, 4-4
- pass/fail testing, 3-19
- \*PCB command, 4-13
- PCB command, 4-42
- P command, 4-43
- peak
  - defining, 3-13
  - excursion, 3-14
  - response, 3-13
  - threshold, 3-15
  - threshold , 3-14
- PEAKEXCU command, 4-43
- PEAK EXCURSION softkey, 3-17, 4-43, 5-37
- PEAK SEARCH softkey, 3-17, 5-37
- PEAKTHRE command, 4-43
- PEAK THRESHOLD softkey, 3-17, 4-43, 5-37
- PEAK TRACK on OFF softkey, 4-37, 5-37
- PENN command, 4-43
- PEN NUM DATA softkey, 5-38
- PEN NUM GRATICULE softkey, 5-38
- PEN NUM MARKER softkey, 5-38
- PEN NUM MEMORY softkey, 5-38
- PEN NUM TEXT softkey, 5-38
- pigtailed device, 2-7
- pigtailed devices, 2-20
- PLOS command, 4-44
- PLOT command, 4-44
- PLOT DATA ON off softkey, 5-38
- PLOT GRAT ON off softkey, 5-39
- PLOT MEM ON off softkey, 5-39

- PLOT MKR ON off softkey, 5-39
- PLOT softkey, 3-48, 4-44, 5-38
- PLOT SPEED softkey, 4-44, 5-39
- plotter, address, 4-4
- PLOTTER not on, not connected, wrong addr error message, 7-8
- PLOTTER NOT READY-PINCH WHEELS UP error message, 7-9
- PLOT TEXT ON off softkey, 5-39
- plotting
  - aborting, 3-50
  - default values, 5-20
  - measurement data values, 3-49
  - on transparencies, 5-39
  - operating parameters, 3-49
- plotting , 3-47
- plotting the display, 3-47, 3-48
- polarization sensitivity, 2-2
- polar vector display, 2-6
- POSITION OFFSET softkey, 3-22, 4-32, 5-39
- POSITION VALUE softkey, 4-33, 5-40
- POWER SUPPLY HOT! error message, 7-9
- PREP command, 4-44
- PRES command, 4-44
- PRESET key, 2-6, 5-40
  - menu map, 5-10
- PREV PAGE softkey, 4-44
- PRIC command, 4-44
- PRINALL command, 4-44
- printer
  - address, 4-4
  - types of, 3-47
- PRINTER not on, not connected, wrong addr error message, 7-9
- printing, 3-47
  - aborting, 3-50
  - display, 3-48
  - measurement data values, 3-49
  - operating parameters, 3-49
- printing , 3-47
- PRINT/PLOT SETUPS softkey, 5-41
- PRINT softkey, 3-48, 4-44, 5-40
- PRINT STANDARD softkey, 4-45, 5-41
- PRIS command, 4-45
- programmable delay line, 3-5, 5-52
- PURG command, 4-45
- PURGE FILE1 softkey, 5-41
- PURGE FILE2 softkey, 5-41
- PURGE FILE3 softkey, 5-41
- PURGE FILE4 softkey, 5-41
- PURGE FILE5 softkey, 5-41
- PURGE FILES softkey, 5-41

**R** RAW ARRAY on OFF softkey, 5-41  
 READ FILE TITLES softkey, 4-45, 5-41  
 rear-panel cables, 1-11  
 RECA command, 4-45  
 RECALL COLORS softkey, 4-45, 5-42  
 RECALL key  
     menu map, 5-6  
 RECALL key , 5-42  
 RECALL REG1 softkey, 5-42  
 RECALL REG2 softkey, 5-42  
 RECALL REG3 softkey, 5-42  
 RECALL REG4 softkey, 5-42  
 RECALL REG5 softkey, 5-42  
 RECEIVER ARM OUTPUT connector, 5-42  
 RECO command, 4-45  
 RED connector, 5-42  
 reference  
     line, 3-45  
     position line, 3-7  
 REFERENCE EXTENSION A connector, 5-42  
 REFERENCE EXTENSION B connector, 5-43  
 REFERENCE POSITION softkey, 4-45, 5-43  
 REFERENCE VALUE softkey, 4-46, 5-43  
 REFP command, 4-45  
 refractive index, 3-5, 3-8  
     entering, 3-8  
 REFRACTIVE INDEX (n) softkey, 3-8, 5-43  
 REFT command, 4-45  
 REFV command, 4-46  
 registers, 3-36  
     status , 4-10  
 regulatory information, 6-16  
 remote control, 4-2  
 repackaging for service, 1-28  
 REQUESTED DATA NOT CURRENTLY AVAILABLE error message, 7-9  
 RESD command, 4-46  
 RESET COLOR softkey, 4-47, 5-43  
 response position, 2-4  
 REST command, 4-46  
 RESTORE DISPLAY softkey, 4-46, 5-43  
 returning to hp, 1-27  
 return loss  
     measurement range, 6-5  
     uncertainty, 6-6  
 RIGHT LOWER softkey, 4-46, 5-44  
 RIGHT UPPER softkey, 4-46, 5-44  
 RIGL command, 4-46  
 RIGU command, 4-46  
 RSCO command, 4-47

\*RST command, 4-14

- S SADD command, 4-47
- safety
  - symbols, x
- sales and service offices, 1-30
- SAVE COLORS softkey, 4-51, 5-44
- SAVE command, 4-47
- SAVE key
  - menu map, 5-7
- SAVE key , 5-44
- SAVE REG1 softkey, 5-44
- SAVE REG2 softkey, 5-44
- SAVE REG3 softkey, 5-44
- SAVE REG4 softkey, 5-44
- SAVE REG5 softkey, 5-44
- SAVUASCII command, 4-47
- SAVUBINA command, 4-47
- SC adapter, 5-54
- SCAL command, 4-47
- SCALE (/DIV) softkey, 5-44
- SCALE/DIV softkey, 4-48
- SCALE PLOT softkey, 4-48, 5-44
- SCALE REF key, 3-7
  - menu map, 5-10
- SCALE REF key , 5-45
- SCAP command, 4-48
- SDEL command, 4-48
- SDON command, 4-48
- SEDI command, 4-48
- SEGMENT softkey, 5-45
- SELECT LETTER softkey, 5-45
- SELECT QUADRANT softkey, 5-45
- sensitivity , 3-5
- serial number, 1-6
- service, 1-28
  - foam inserts, 1-28
  - repackaging, 1-28
  - returning to factory, 1-28
- SERVICE MENU softkey, 4-49, 5-41
- service repair form, 1-29
- SET ADDRESSES softkey, 3-44, 5-46
- shipping containers, 1-27
- SING command, 4-48
- SINGLE POINT softkey, 5-46
- SINGLE softkey, 3-6, 4-48, 5-46
- single sweeps, 3-6
- SL annotation, 3-21

SLOPING LINE softkey, 5-46  
 SOFR command, 4-49  
 softkeys, vi  
     corresponding commands , 4-54  
 SOUR1300 command, 4-49  
 SOUR1550 command, 4-49  
 source  
     1300 nm, 3-6  
     1550 nm, 3-6  
     external, 2-22, 3-6  
 SOURCE 1 TEMPERATURE LOOP OPEN error message, 7-9  
 SOURCE 2 TEMPERATURE LOOP OPEN error message, 7-9  
 SOURCE ARM INPUT connector, 2-26, 5-46  
 SOURCE OFF softkey, 4-49, 5-47  
 source wavelength, 3-6  
 SOUREXT command, 4-49  
 SOUROFF command, 4-49  
 SPACE softkey, 5-47  
 span, 2-5, 3-5  
 SPAN command, 4-49  
 SPAN key , 5-47  
 SP annotation, 3-21  
 SPAN softkey, 4-50  
 spurious responses, 6-12  
 \*SRE, 4-9  
 \*SRE command, 4-14  
 SRE command, 4-50  
 ST adapter, 5-54  
 standards, 2-20  
 STAR command, 4-50  
 START key , 5-47  
 START softkey, 4-50  
 status  
     byte , 4-9  
     HP-IB, 4-2  
     instrument, 4-9  
     reporting registers, 4-10  
 \* status notation, vii, 5-11  
 \*STB?, 4-9  
 \*STB? command, 4-14  
 STB? command, 4-50  
 STOP command, 4-50  
 STOP key , 5-47  
 STOP softkey, 4-50  
 STOR command, 4-50  
 STORE FILE1 softkey, 5-48  
 STORE FILE2 softkey, 5-48  
 STORE FILE3 softkey, 5-48  
 STORE FILE4 softkey, 5-48

- STORE FILE5 softkey, 5-48
- STORE TO DISK softkey, 4-45, 4-50, 5-48
- storing traces, 3-34
- SVCO command, 4-51
- sweep
  - restarting, 3-6
  - single, 3-6
  - speed, 3-4
- sweep-to-sweep repeatability, 6-8
- SYNTAX ERROR error message, 7-10
- system controller, 4-4
- SYSTEM CONTROLLER softkey, 3-44, 5-48
- SYSTEM IS NOT IN REMOTE error message, 7-10
- SYSTEM key
  - menu map, 5-8
- SYSTEM key , 5-48

**T** talker/listener, 4-4

- TALKER/LISTENER softkey, 5-48
- TALKER/LISTER softkey, 4-51
- TALKLIST command, 4-51
- termination, low reflection, 2-3
- test cannot execute when source is off error message, 7-10
- TEST PORT connector, 5-49
- TEST PORT OVERLOAD, REDUCE POWER error message, 7-10
- TEST SET NOT FOUND - CHECK I/O CABLE error message, 7-10
- TEXT softkey, 4-21, 5-49
- ThinkJet, 3-47
- TIME command, 4-51
- TIME softkey, 3-7, 5-49
- TINT command, 4-51
- TINT softkey, 4-51, 5-49
- TITF command, 4-51
- TITL command, 4-52
- TITLE FILE1 softkey, 5-50
- TITLE FILE2 softkey, 5-50
- TITLE FILE3 softkey, 5-50
- TITLE FILE4 softkey, 5-50
- TITLE FILE5 softkey, 5-50
- TITLE FILES softkey, 4-51, 5-50
- TITLE REG1 softkey, 5-50
- TITLE REG2 softkey, 5-50
- TITLE REG3 softkey, 5-50
- TITLE REG4 softkey, 5-50
- TITLE REG5 softkey, 5-50
- TITLE REGISTER softkey, 4-52, 5-50
- TITLE softkey, 4-52, 5-49
- TITR command, 4-52



- trace
    - averaging, 3-9
    - data, 3-13
    - memory, 3-13, 3-34
    - storing, 3-34
  - TRIG command, 4-52
  - TRIGGER HOLD softkey, 4-27, 5-50
  - TRIGGER TRIG OFF softkey, 4-26
  - \*TST? command, 4-14
  - two-event spatial accuracy, 6-9
  - two-event spatial resolution, 6-10
- U**
- $\Delta$  MENU softkey, 5-11
  - $\Delta$  MODE OFF softkey, 4-22
  - $\Delta$  OFF softkey, 5-11
  - $\Delta$  REF = 4 softkey, 4-22
  - $\Delta$ REF=FIXED MKR softkey, 5-11
  - $\Delta$ REF=MKR 1 softkey, 5-11
  - $\Delta$ REF=MKR 2 softkey, 5-11
  - $\Delta$ REF=MKR 3 softkey, 5-11
  - $\Delta$ REF=MKR 4 softkey, 5-11
  - $\Delta$ REF= $\Delta$  FIXED MKR softkey, 4-22
  - UP command, 4-52
  - UPPER LIMIT softkey, 4-33, 5-50
  - USEPASC command, 4-52
  - USE PASS CONTROL softkey, 4-52, 5-51
  - USER STD [10%] softkey, 5-51
- V**
- verification, 1-12
  - vertical scale, 3-7
  - VERT LOG MAG softkey, 3-7, 5-51
  - viewing traces, 3-34
  - VOLUME NUMBER softkey, 5-51
- W**
- WAIT command, 4-53
  - WARNING softkey, 5-52
  - warning text, 3-45
  - warranty, xii
- X**
- x1 key, 5-52
- Z**
- ZERO SPAN on OFF softkey, 3-5, 4-53, 5-52
  - ZERS command, 4-53
  - zoom , 3-4

---